

OptiPlex 3080 Tower

Service Manual

Notes, cautions, and warnings

 **NOTE:** A NOTE indicates important information that helps you make better use of your product.

 **CAUTION:** A CAUTION indicates either potential damage to hardware or loss of data and tells you how to avoid the problem.

 **WARNING:** A WARNING indicates a potential for property damage, personal injury, or death.

Chapter 1: Working on your computer	6
Safety instructions.....	6
Before working inside your computer.....	6
Safety precautions.....	7
Electrostatic discharge—ESD protection.....	7
ESD field service kit	8
After working inside your computer.....	9
Chapter 2: Technology and components	10
Graphics options.....	10
Intel UHD 610 Graphics.....	10
Intel UHD 630 Graphics.....	10
NVIDIA GeForce GT 730.....	11
AMD Radeon RX 640.....	12
AMD Radeon R5 430.....	13
System management features.....	13
Dell Client Command Suite for In-Band systems management	14
Chapter 3: Major components of your system	15
Chapter 4: Disassembly and reassembly	18
Side cover.....	18
Removing the side cover.....	18
Installing the side cover.....	20
Front bezel.....	21
Removing the front bezel.....	21
Installing the front bezel.....	22
Fan duct.....	23
Removing the fan duct.....	23
Installing the fan duct.....	23
Hard-drive assembly.....	24
Removing the 2.5-inch hard-disk drive assembly.....	24
Removing the 2.5-inch hard-disk drive bracket.....	25
Installing the 2.5-inch hard-disk drive bracket.....	26
Installing the 2.5-inch hard-disk drive assembly.....	27
3.5-inch hard drive.....	29
Removing the 3.5 inch hard drive.....	29
Installing the 3.5 inch hard drive.....	29
Solid-state drive.....	30
Removing the M.2 2230 PCIe solid-state drive.....	30
Installing the M.2 2230 PCIe solid-state drive.....	31
Removing the M.2 2280 PCIe solid-state drive.....	32
Installing the M.2 2280 PCIe solid-state drive.....	33
Memory modules.....	34

Removing the memory modules.....	34
Installing the memory modules.....	35
Processor fan and heat-sink assembly.....	36
Removing the processor fan and heat-sink assembly.....	36
Installing the processor fan and heat-sink assembly.....	37
Processor.....	38
Removing the processor.....	38
Installing the processor.....	39
Graphics card.....	41
Removing the graphics card.....	41
Installing the graphics card.....	42
Graphical processing unit.....	43
Removing the powered GPU.....	43
Installing the powered GPU.....	43
Coin-cell battery.....	43
Removing the coin-cell battery.....	43
Installing the coin-cell battery.....	44
WLAN card.....	45
Removing the WLAN card.....	45
Installing the WLAN card.....	46
Slim optical-drive.....	48
Removing the Slim-Optical Disk Drive.....	48
Installing the Slim-Optical Disk Drive.....	48
Slim optical-drive bracket.....	49
Removing the slim-ODD bracket.....	49
Installing the slim-ODD bracket.....	50
Speaker.....	51
Removing the speaker.....	51
Installing the speaker.....	51
Power button.....	52
Removing the power button.....	52
Installing the power button.....	53
Power-supply unit.....	54
Removing the power-supply unit.....	54
Installing the power-supply unit.....	56
Intrusion switch.....	58
Removing the intrusion switch.....	58
Installing the intrusion switch.....	59
Optional I/O modules (Type C/ HDMI/VGA/DP/Serial).....	60
Removing optional I/O modules (Type C/ HDMI/VGA/DP/Serial).....	60
Installing optional I/O modules (Type-C/HDMI/VGA/DP/Serial).....	61
System board.....	65
Removing the system board.....	65
Installing the system board.....	68
Chapter 5: Troubleshooting.....	72
Dell SupportAssist Pre-boot System Performance Check diagnostics.....	72
Running the SupportAssist Pre-Boot System Performance Check.....	72
Diagnostic LED behavior.....	73
Diagnostic error messages.....	74

System error messages.....	77
WiFi power cycle.....	77
Chapter 6: Getting help.....	79
Contacting Dell.....	79









Working on your computer

Topics:

- [Safety instructions](#)

Safety instructions

Use the following safety guidelines to protect your computer from potential damage and to ensure your personal safety. Unless otherwise noted, each procedure included in this document assumes that you have read the safety information that shipped with your computer.

-  **NOTE:** Before working inside your computer, read the safety information that is shipped with your computer. For more safety best practices, see the Regulatory Compliance home page at www.dell.com/regulatory_compliance.
-  **NOTE:** Disconnect your computer from all power sources before opening the computer cover or panels. After you finish working inside the computer, replace all covers, panels, and screws before connecting your computer to an electrical outlet.
-  **CAUTION:** To avoid damaging the computer, ensure that the work surface is flat, dry and clean.
-  **CAUTION:** To avoid damaging the components and cards, handle them by their edges, and avoid touching the pins and the contacts.
-  **CAUTION:** You should only perform troubleshooting and repairs as authorized or directed by the Dell technical assistance team. Damage due to servicing that is not authorized by Dell is not covered by your warranty. See the safety instructions that is shipped with the product or at www.dell.com/regulatory_compliance.
-  **CAUTION:** Before touching anything inside your computer, ground yourself by touching an unpainted metal surface, such as the metal at the back of the computer. While you work, periodically touch an unpainted metal surface to dissipate static electricity which could harm internal components.
-  **CAUTION:** When you disconnect a cable, pull it by its connector or its pull tab, not the cable itself. Some cables have connectors with locking tabs or thumb-screws that you must disengage before disconnecting the cable. When disconnecting cables, keep them evenly-aligned to avoid bending the connector pins. When connecting cables, ensure that the ports and the connectors are correctly oriented and aligned.
-  **CAUTION:** Press and eject any installed card from the media-card reader.
-  **NOTE:** The color of your computer and certain components may appear differently than shown in this document.

Before working inside your computer

About this task

-  **NOTE:** The images in this document may differ from your computer depending on the configuration you ordered.

Steps

1. Save and close all open files and exit all open applications.
2. Shut down your computer. Click **Start** >  **Power** > **Shut down**.

 **NOTE:** If you are using a different operating system, see the documentation of your operating system for shut-down instructions.

3. Disconnect your computer and all attached devices from their electrical outlets.
4. Disconnect all attached network devices and peripherals, such as keyboard, mouse, and monitor from your computer.

 **CAUTION:** To disconnect a network cable, first unplug the cable from your computer and then unplug the cable from the network device.

5. Remove any media card and optical disc from your computer, if applicable.

Safety precautions

The safety precautions chapter details the primary steps to be taken before performing any disassembly instructions.

Observe the following safety precautions before you perform any installation or break/fix procedures involving disassembly or reassembly:

- Turn off the system and all attached peripherals.
- Disconnect the system and all attached peripherals from AC power.
- Disconnect all network cables, telephone, and telecommunications lines from the system.
- Use an ESD field service kit when working inside any desktop to avoid electrostatic discharge (ESD) damage.
- After removing any system component, carefully place the removed component on an anti-static mat.
- Wear shoes with non-conductive rubber soles to reduce the chance of getting electrocuted.

Standby power

Dell products with standby power must be unplugged before you open the case. Systems that incorporate standby power are essentially powered while turned off. The internal power enables the system to be remotely turned on (wake on LAN) and suspended into a sleep mode and has other advanced power management features.

Unplugging, pressing and holding the power button for 15 seconds should discharge residual power in the system board.

Bonding

Bonding is a method for connecting two or more grounding conductors to the same electrical potential. This is done through the use of a field service electrostatic discharge (ESD) kit. When connecting a bonding wire, ensure that it is connected to bare metal and never to a painted or non-metal surface. The wrist strap should be secure and in full contact with your skin, and ensure that you remove all jewelry such as watches, bracelets, or rings prior to bonding yourself and the equipment.

Electrostatic discharge—ESD protection

ESD is a major concern when you handle electronic components, especially sensitive components such as expansion cards, processors, memory DIMMs, and system boards. Very slight charges can damage circuits in ways that may not be obvious, such as intermittent problems or a shortened product life span. As the industry pushes for lower power requirements and increased density, ESD protection is an increasing concern.

Due to the increased density of semiconductors used in recent Dell products, the sensitivity to static damage is now higher than in previous Dell products. For this reason, some previously approved methods of handling parts are no longer applicable.

Two recognized types of ESD damage are catastrophic and intermittent failures.

- **Catastrophic** – Catastrophic failures represent approximately 20 percent of ESD-related failures. The damage causes an immediate and complete loss of device functionality. An example of catastrophic failure is a memory DIMM that has received a static shock and immediately generates a "No POST/No Video" symptom with a beep code emitted for missing or nonfunctional memory.
- **Intermittent** – Intermittent failures represent approximately 80 percent of ESD-related failures. The high rate of intermittent failures means that most of the time when damage occurs, it is not immediately recognizable. The DIMM receives a static shock, but the tracing is merely weakened and does not immediately produce outward symptoms related to the damage. The weakened trace may take weeks or months to melt, and in the meantime may cause degradation of memory integrity, intermittent memory errors, etc.

The more difficult type of damage to recognize and troubleshoot is the intermittent (also called latent or "walking wounded") failure.

Perform the following steps to prevent ESD damage:

- Use a wired ESD wrist strap that is properly grounded. The use of wireless anti-static straps is no longer allowed; they do not provide adequate protection. Touching the chassis before handling parts does not ensure adequate ESD protection on parts with increased sensitivity to ESD damage.
- Handle all static-sensitive components in a static-safe area. If possible, use anti-static floor pads and workbench pads.
- When unpacking a static-sensitive component from its shipping carton, do not remove the component from the anti-static packing material until you are ready to install the component. Before unwrapping the anti-static packaging, ensure that you discharge static electricity from your body.
- Before transporting a static-sensitive component, place it in an anti-static container or packaging.

ESD field service kit

The unmonitored Field Service kit is the most commonly used service kit. Each Field Service kit includes three main components: anti-static mat, wrist strap, and bonding wire.

Components of an ESD field service kit

The components of an ESD field service kit are:

- **Anti-Static Mat** – The anti-static mat is dissipative and parts can be placed on it during service procedures. When using an anti-static mat, your wrist strap should be snug and the bonding wire should be connected to the mat and to any bare metal on the system being worked on. Once deployed properly, service parts can be removed from the ESD bag and placed directly on the mat. ESD-sensitive items are safe in your hand, on the ESD mat, in the system, or inside a bag.
- **Wrist Strap and Bonding Wire** – The wrist strap and bonding wire can be either directly connected between your wrist and bare metal on the hardware if the ESD mat is not required, or connected to the anti-static mat to protect hardware that is temporarily placed on the mat. The physical connection of the wrist strap and bonding wire between your skin, the ESD mat, and the hardware is known as bonding. Use only Field Service kits with a wrist strap, mat, and bonding wire. Never use wireless wrist straps. Always be aware that the internal wires of a wrist strap are prone to damage from normal wear and tear, and must be checked regularly with a wrist strap tester in order to avoid accidental ESD hardware damage. It is recommended to test the wrist strap and bonding wire at least once per week.
- **ESD Wrist Strap Tester** – The wires inside of an ESD strap are prone to damage over time. When using an unmonitored kit, it is a best practice to regularly test the strap prior to each service call, and at a minimum, test once per week. A wrist strap tester is the best method for doing this test. If you do not have your own wrist strap tester, check with your regional office to find out if they have one. To perform the test, plug the wrist-strap's bonding-wire into the tester while it is strapped to your wrist and push the button to test. A green LED is lit if the test is successful; a red LED is lit and an alarm sounds if the test fails.
- **Insulator Elements** – It is critical to keep ESD sensitive devices, such as plastic heat sink casings, away from internal parts that are insulators and often highly charged.
- **Working Environment** – Before deploying the ESD Field Service kit, assess the situation at the customer location. For example, deploying the kit for a server environment is different than for a desktop or portable environment. Servers are typically installed in a rack within a data center; desktops or portables are typically placed on office desks or cubicles. Always look for a large open flat work area that is free of clutter and large enough to deploy the ESD kit with additional space to accommodate the type of system that is being repaired. The workspace should also be free of insulators that can cause an ESD event. On the work area, insulators such as Styrofoam and other plastics should always be moved at least 12 inches or 30 centimeters away from sensitive parts before physically handling any hardware components
- **ESD Packaging** – All ESD-sensitive devices must be shipped and received in static-safe packaging. Metal, static-shielded bags are preferred. However, you should always return the damaged part using the same ESD bag and packaging that the new part arrived in. The ESD bag should be folded over and taped shut and all the same foam packing material should be used in the original box that the new part arrived in. ESD-sensitive devices should be removed from packaging only at an ESD-protected work surface, and parts should never be placed on top of the ESD bag because only the inside of the bag is shielded. Always place parts in your hand, on the ESD mat, in the system, or inside an anti-static bag.
- **Transporting Sensitive Components** – When transporting ESD sensitive components such as replacement parts or parts to be returned to Dell, it is critical to place these parts in anti-static bags for safe transport.

ESD protection summary

It is recommended that all field service technicians use the traditional wired ESD grounding wrist strap and protective anti-static mat at all times when servicing Dell products. In addition, it is critical that technicians keep sensitive parts separate from all insulator parts while performing service and that they use anti-static bags for transporting sensitive components.

After working inside your computer

About this task

 **CAUTION:** Leaving stray or loose screws inside your computer may severely damage your computer.

Steps

1. Replace all screws and ensure that no stray screws remain inside your computer.
2. Connect any external devices, peripherals, or cables you removed before working on your computer.
3. Replace any media cards, discs, or any other parts that you removed before working on your computer.
4. Connect your computer and all attached devices to their electrical outlets.
5. Turn on your computer.

Technology and components

This chapter details the technology and components available in the system.

Topics:

- [Graphics options](#)
- [System management features](#)

Graphics options

Intel UHD 610 Graphics

Table 1. Intel UHD 610 Graphics specifications

Intel UHD 610 Graphics	
Bus Type	Integrated
Memory Type	UMA
Graphics Level	Celeron/Pentium Gold: GT2 (UHD)
Overlay Planes	Yes
Operating Systems Graphics/ Video API Support	DirectX 12, OpenGL (4.5 from Intel CML POR)
Supports maximum resolution	<ul style="list-style-type: none"> • DP: 4096 x 2304 @60 Hz, 24 bpp • Option DP: 4096 x 2304 @60 Hz • Option USB type-C Alt mode: 4096 x 2304 @60 Hz • Option VGA: 1920 x 1200 @60 Hz • Option HDMI2.0: 4096 x 2160 @60 Hz
Number of display supported	Up to three displays supported
Multiple Display Support	<ul style="list-style-type: none"> • Two motherboard integrated DP1.4 HBR2 + One video option (VGA/DP1.4 HBR2/HDMI2.0/USB3.2 Gen2 type-C Alt-mode)
External Connectors	Two MB integrated DP1.4 HBR2 + One video option (VGA/DP1.4 HBR2/HDMI2.0/USB3.2 Gen2 type-C Alt-mode)

Intel UHD 630 Graphics

Table 2. Intel UHD 630 Graphics specifications

Intel UHD 630 Graphics	
Bus Type	Integrated
Memory Type	UMA
Graphics Level	i3/i5: GT2 (UHD)
Overlay Planes	Yes
Operating Systems Graphics/ Video API Support	DirectX 12, OpenGL (4.5 from Intel CML POR)

Table 2. Intel UHD 630 Graphics specifications (continued)

Intel UHD 630 Graphics	
Supports maximum resolution	<ul style="list-style-type: none"> ● DP: 4096 x 2304 @60 Hz, 24 bpp ● Option DP: 4096 x 2304 @60 Hz ● Option USB type-C Alt mode: 4096 x 2304 @60 Hz ● Option VGA: 1920 x 1200 @60 Hz ● Option HDMI2.0: 4096 x 2160 @60 Hz
Number of display supported	Up to three displays supported
Multiple Display Support	<ul style="list-style-type: none"> ● Two motherboard integrated DP1.4 HBR2 + One video option (VGA/DP1.4 HBR2/HDMI2.0/USB3.2 Gen2 type-C Alt-mode)
External Connectors	Two MB integrated DP1.4 HBR2 + One video option (VGA/DP1.4 HBR2/HDMI2.0/USB3.2 Gen2 type-C Alt-mode)

NVIDIA GeForce GT 730

Table 3. NVIDIA GeForce GT 730 specifications

Feature	Values
GPU frequency	902 MHz
DirectX	12.0
Shader model	5.0
Open CL	1.1
Open GL	4.5
GPU memory interface	64 bit
PCIe bus	PCIe 3.0 x8
Display support	One DisplayPort 1.2
Graphics memory configuration	2 GB, GDDR5
Graphics memory clock speed	2.5 GHz
Active fan sink	2-pin excluded fan controller
Slot number	Single slot
PCB form factor	Low profile
PCB layer	4 layer
PCB solder mask	Green
Bracket form factor	Low profile
Maximum resolution	3840 x 2160
Power consumption	u

Table 3. NVIDIA GeForce GT 730 specifications (continued)

Feature	Values
	<ul style="list-style-type: none"> • 20 W TDP • 30 W TGP
3D mark performance	<ul style="list-style-type: none"> • 3DMark 11 (P): E4131 • 3Dmark Vantage(P):

AMD Radeon RX 640

Table 4. AMD Radeon RX 640 specifications

Feature	Values
GPU frequency	1.2 GHz
DirectX	12
Shader model	5.0
Open CL	2.0
Open GL	4.5
GPU memory interface	128 bit
PCIe bus	PCIe 3.0 x8
Display support	<ul style="list-style-type: none"> • Two Mini DisplayPorts • One DisplayPort
Graphics memory configuration	4 GB, GDDR5
Graphics memory clock speed	7 Gbps
Active fan sink	4-pin embedded fan controller
Slot number	Single slot
PCB form factor	Low profile
PCB layer	6 layer
PCB solder mask	Green
Bracket form factor	Low profile
Maximum resolution	5120 x 2880
Power consumption	50 W
3D mark performance	3DMark 11 (P): 5315

AMD Radeon R5 430

Table 5. AMD Radeon R5 430 specifications

Feature	Values
GPU frequency	780 MHz
DirectX	11.2
Shader model	5.0
Open CL	1.2
Open GL	4.2
GPU memory interface	64 bit
PCIe bus	PCIe 3.0 x8
Display support	1 DisplayPort 1.2
Graphics memory configuration	2 GB, GDDR5
Graphics memory clock speed	1.5 GHz
Active fan sink	2-pin excluded fan controller
Slot number	Single slot
PCB form factor	Low profile
PCB layer	6 layer
PCB solder mask	Green
Bracket form factor	<ul style="list-style-type: none">• Full height• Low profile
Maximum resolution	4096 x 2160
Power consumption	<ul style="list-style-type: none">• 25 W TDP• 35 W TGP
3D mark performance	<ul style="list-style-type: none">• 3DMark 11 (P)• 3Dmark Vantage(P)

System management features

Dell commercial systems come with a number of systems management options that are included by default for In-Band management with the Dell Client Command Suite. In-Band management is when the system has a functional operating system and the device is connected to a network so that it can be managed. The Dell Client Command Suite of tools can be leveraged individually or with a systems management console like SCCM, LANDESK, KACE, etc.

We also offer Out-of-Band management as an option. Out-of-band management is when the system does not have a functional operating system or is turned off and you still want to be able to manage the system in that state.

Dell Client Command Suite for In-Band systems management

Dell Client Command Suite is a free toolkit available for download, for all Latitude Rugged tablets at dell.com/support, automates and streamlines systems management tasks, saving time, money, and resources. It consists of the following modules that can be used independently, or with a variety of systems management consoles such as SCCM.

Dell Client Command Suite's integration with VMware Workspace ONE Powered by AirWatch, now allows customers to manage their Dell client hardware from the cloud, using a single Workspace ONE console.

Dell Command | Deploy enables easy operating system (OS) deployment across all major OS deployment methodologies and provides numerous system-specific drivers that have been extracted and reduced to an OS-consumable state.

Dell Command | Configure is a graphical user interface (GUI) admin tool for configuring and deploying hardware settings in a pre-OS or post-OS environment, and it operates seamlessly with SCCM and Airwatch and can be self-integrated into LANDesk and KACE. Simply, this is all about the BIOS. Command | Configure allows you to remotely automate and configure over 150+ BIOS settings for a personalized user experience.

Dell Command | PowerShell Provider can do the same things as Command | Configure, but with a different method. PowerShell is a scripting language that allows customers to create a customized and dynamic configuration process.

Dell Command | Monitor is a Windows Management Instrumentation (WMI) agent that provides IT admins with an extensive inventory of the hardware and health-state data. Admins can also configure hardware remotely by using command line and scripting.

Dell Command | Power Manager (end-user tool) is a GUI-based factory-installed battery management tool that allows end users to choose the battery management methods that meet their personal preferences or work schedule without sacrificing IT's capability to control those settings with Group Policy.

Dell Command | Update (end-user tool) is factory-installed and allows admins to individually manage and automatically present and install Dell updates to the BIOS, drivers, and software. Command | Update eliminates the time-consuming hunting and pecking process of update installation.

Dell Command | Update Catalog provides searchable metadata that allows the management console to retrieve the latest system-specific updates (driver, firmware or BIOS). The updates are then delivered seamlessly to end-users using the customer's systems management infrastructure that is consuming the catalog (like SCCM).

Dell Command | vPro Out of Band console extends hardware management to systems that are offline or have an unreachable OS (Dell exclusive features).

Dell Command | Integration Suite for System Center - This suite integrates all the key components of the Client Command Suite into Microsoft System Center Configuration Manager 2012 and Current Branch versions.

Major components of your system

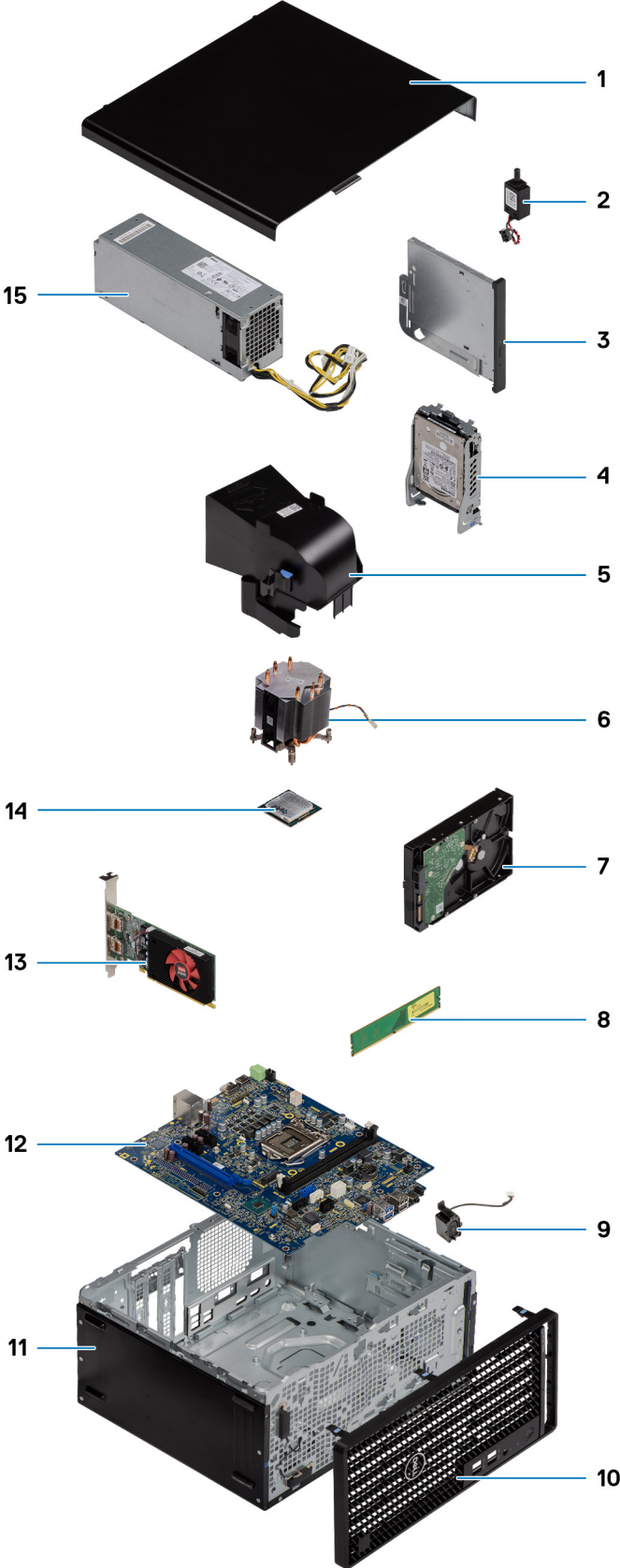

 **NOTE:** Dell provides a list of components and their part numbers for the original system configuration purchased. These parts are available according to warranty coverages purchased by the customer. Contact your Dell sales representative for purchase options.

Disassembly and reassembly

Topics:

- Side cover
- Front bezel
- Fan duct
- Hard-drive assembly
- 3.5-inch hard drive
- Solid-state drive
- Memory modules
- Processor fan and heat-sink assembly
- Processor
- Graphics card
- Graphical processing unit
- Coin-cell battery
- WLAN card
- Slim optical-drive
- Slim optical-drive bracket
- Speaker
- Power button
- Power-supply unit
- Intrusion switch
- Optional I/O modules (Type C/ HDMI/VGA/DP/Serial)
- System board

Side cover

Removing the side cover

Prerequisites

1. Follow the procedure in [before working inside your computer](#).

 **NOTE:** Ensure that you remove the security cable from the security-cable slot (if applicable).

About this task

The following images indicate the location of the side cover and provide a visual representation of the removal procedure.



Steps

1. Loosen the thumbscrew (#6-32) that secures the side cover to the computer.
2. Slide the side cover towards the rear of the computer and lift the cover away from the computer.

Installing the side cover

Prerequisites

If you are replacing a component, remove the existing component before performing the installation procedure.

About this task

The following image indicates the location of the side cover and provides a visual representation of the installation procedure.



Steps

1. Locate the side cover slot on your computer.
2. Align the tabs on the side cover with the slots on the chassis.
3. Slide the side cover towards the front of the computer to install it.
4. Tighten the thumbscrew (#6-32) to secure the side cover to the computer.

Next steps

1. Follow the procedure in [after working inside your computer](#).

Front bezel

Removing the front bezel

Prerequisites

1. Follow the procedure in [before working inside your computer](#).
2. Remove the [side cover](#).

About this task

The following images indicate the location of the front bezel and provide a visual representation of the removal procedure.

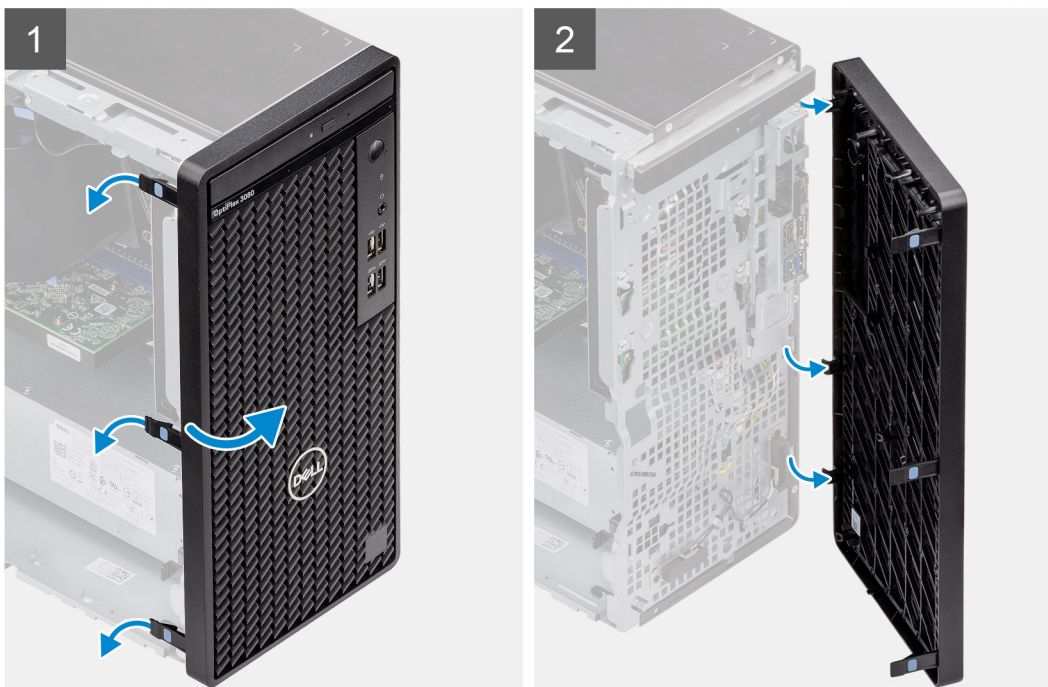

Steps

1. Pry the retention tabs to release the front bezel from the computer.

2. Slightly pull the front bezel and gently rotate to release the other tabs on the bezel from the slots in the computer chassis.
3. Remove the front bezel from the computer.

Installing the front bezel

Prerequisites

If you are replacing a component, remove the existing component before performing the installation procedure.

About this task

The following image indicates the location of the front bezel and provides a visual representation of the installation procedure.



Steps

1. Position the front bezel to align the tabs on the bezel with the slots on the chassis.
2. Press the bezel until the tabs clicks into place.

Next steps

1. Install the [side cover](#).
2. Follow the procedure in [after working inside your computer](#).

Fan duct

Removing the fan duct

Prerequisites

1. Follow the procedure in [before working inside your computer](#).
2. Remove the [side cover](#).

About this task

The following images indicate the location of the fan duct and provide a visual representation of the removal procedure.

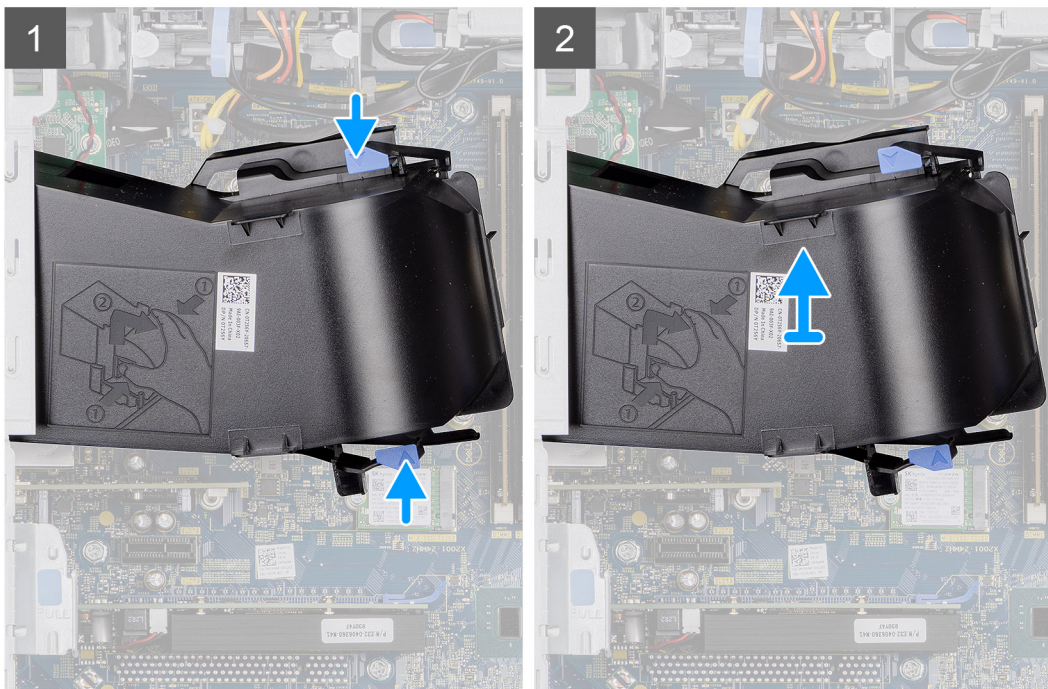
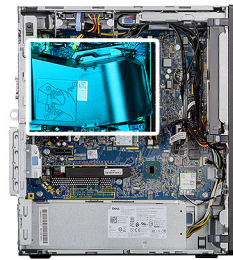

Steps

1. Press the retention tabs on both sides of the fan duct to release it.
2. Pull and remove the fan duct from the computer.

Installing the fan duct

Prerequisites

If you are replacing a component, remove the existing component before performing the installation procedure.

About this task

The following image indicates the location of the fan duct and provides a visual representation of the installation procedure.

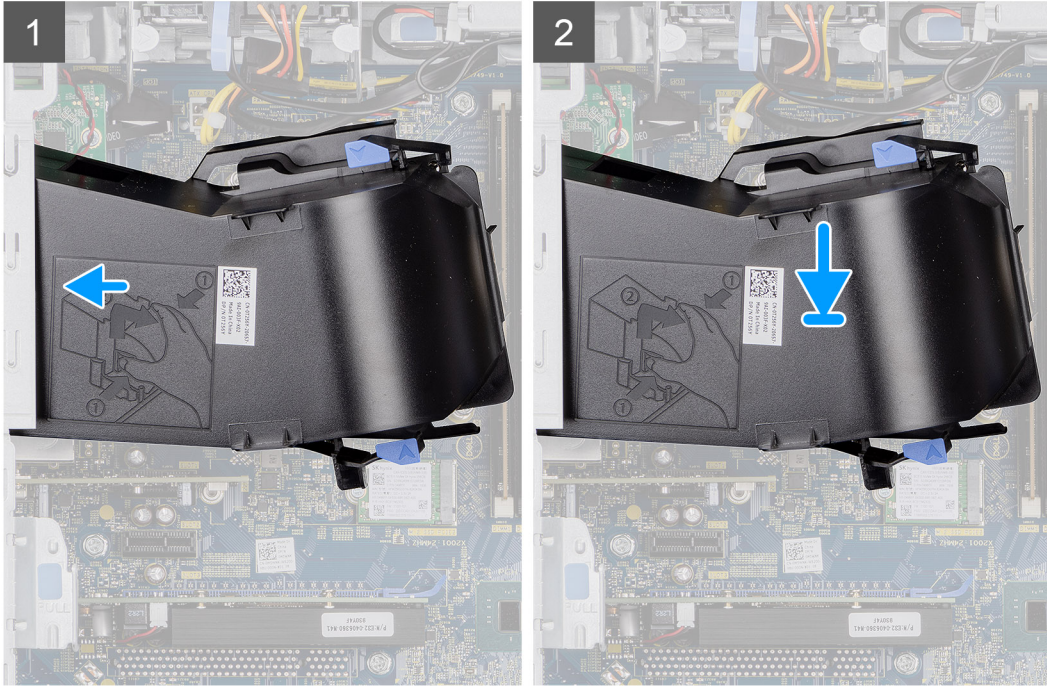
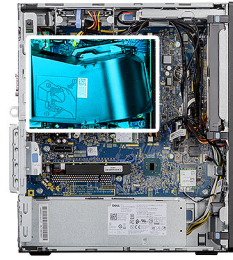

Steps

1. Position the fan duct to align it with the slots on the computer chassis.
2. Press the fan duct until it clicks into place.

Next steps

1. Install the [side cover](#).
2. Follow the procedure in [after working inside your computer](#).

Hard-drive assembly

Removing the 2.5-inch hard-disk drive assembly

Prerequisites

1. Follow the procedure in [before working inside your computer](#).
2. Remove the [side cover](#).
3. Remove the [fan duct](#).

About this task

The following images indicate the location of the 2.5-inch hard-disk drive assembly and provide a visual representation of the removal procedure.

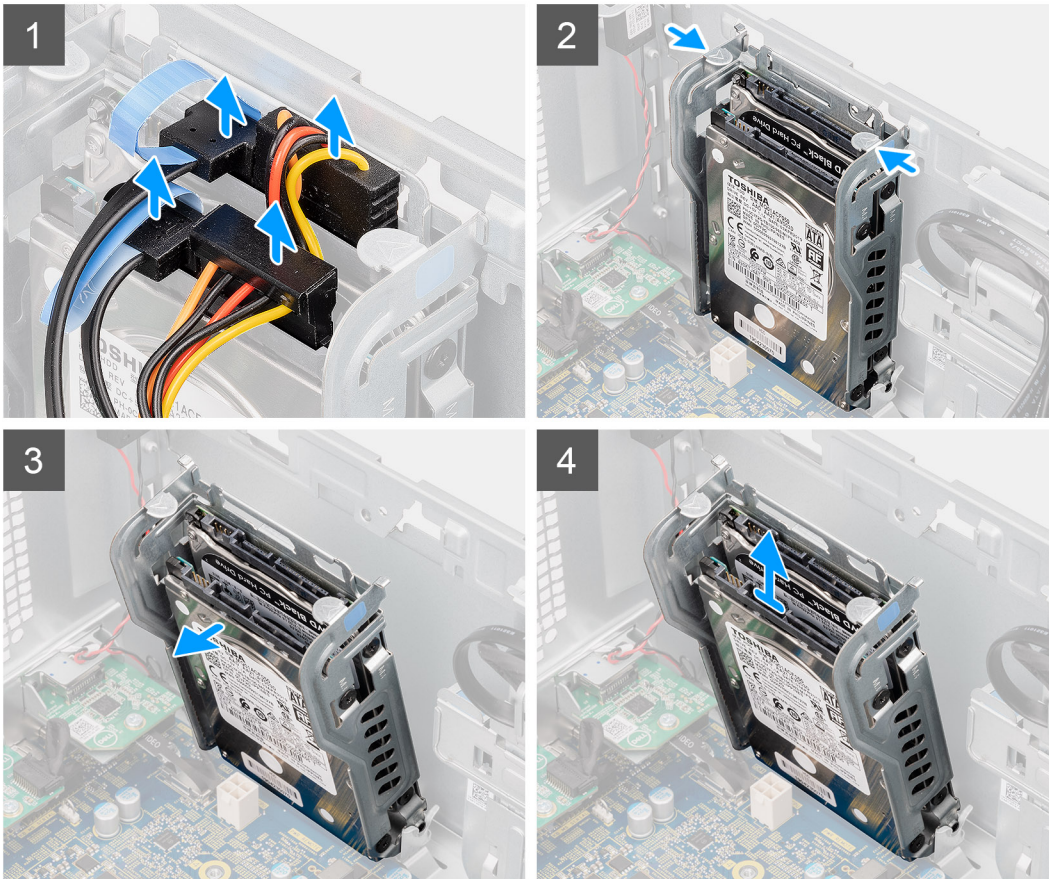
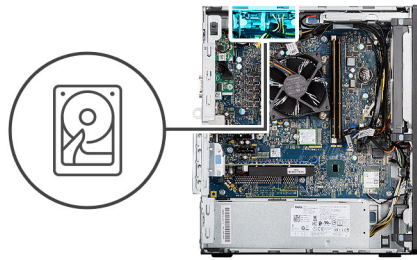

Steps

1. Disconnect the hard-drive data and power cables from the connectors on the 2.5-inch hard-disk drive module.
2. Press the release tabs on both the sides of the hard-disk drive bracket to release it from the slots on the computer chassis.
3. Tilt the hard-disk drive assembly slightly at an angle.
4. Lift the hard-disk drive assembly from the computer.

i NOTE: Note the orientation of the hard-disk drive so that you can replace it correctly.

Removing the 2.5-inch hard-disk drive bracket

Prerequisites

1. Follow the procedure in [before working inside your computer](#).
2. Remove the [side cover](#).
3. Remove the [fan duct](#).
4. Remove the [2.5 in. hard-disk drive assembly](#).

About this task

The following images indicate the location of the 2.5-inch hard-disk drive bracket and provides a visual representation of the removal procedure.



4x
M3x3.5

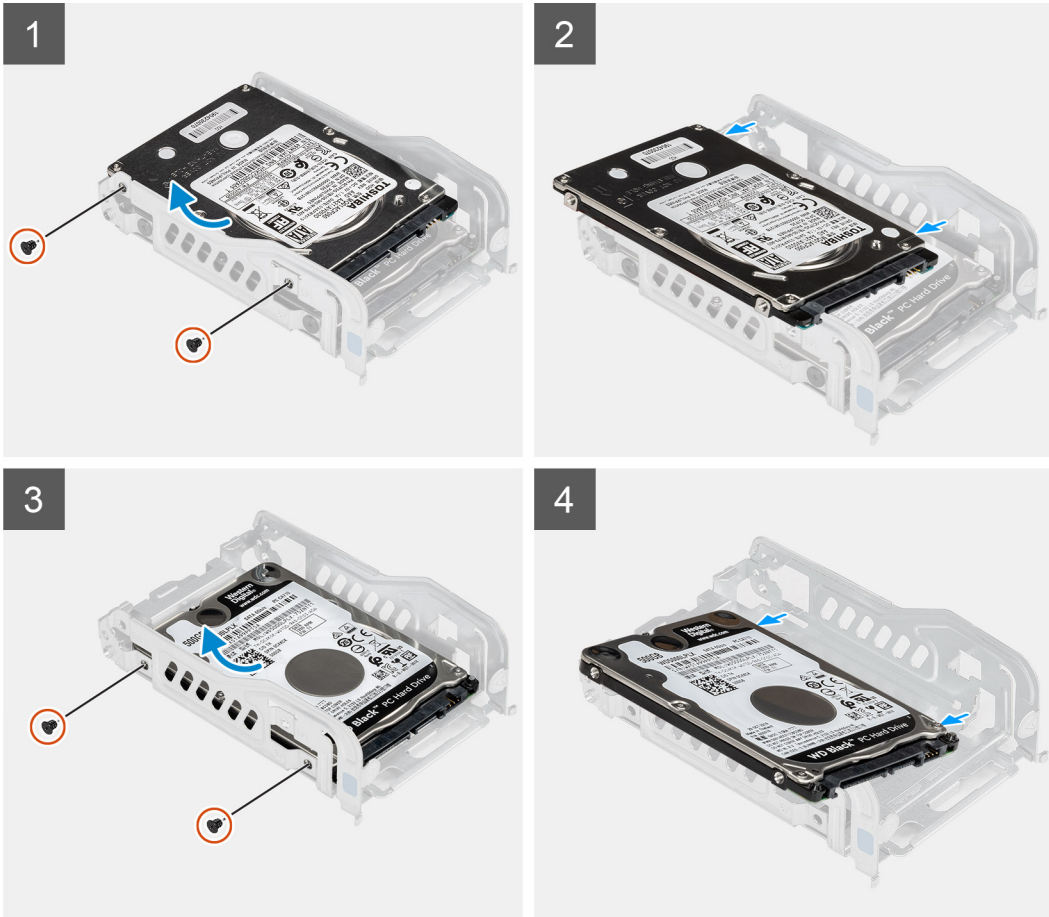

Steps

1. Remove the two (M3x3.5) screws that secure the first hard-disk drive to the hard-drive metal bracket.
2. Slide and lift the hard drive from the hard-drive metal bracket.
3. Remove the two (M3x3.5) screws that secure the second hard drive to the hard-disk drive metal bracket.
4. Slide and lift the second hard-disk drive from the hard-disk drive metal bracket.

Installing the 2.5-inch hard-disk drive bracket

Prerequisites

If you are replacing a component, remove the existing component before performing the installation procedure.

About this task

The following image indicates the location of the 2.5-inch hard-disk drive bracket and provides a visual representation of the installation procedure.



4x
M3x3.5

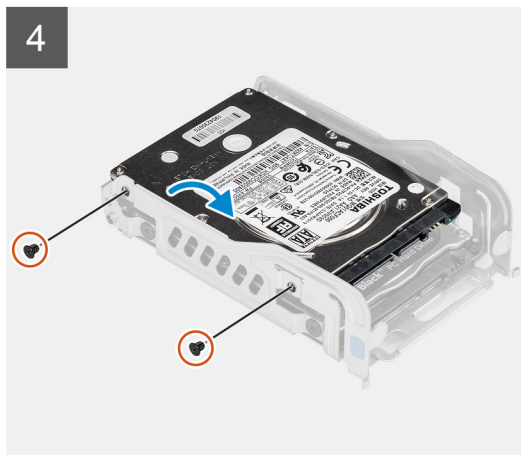
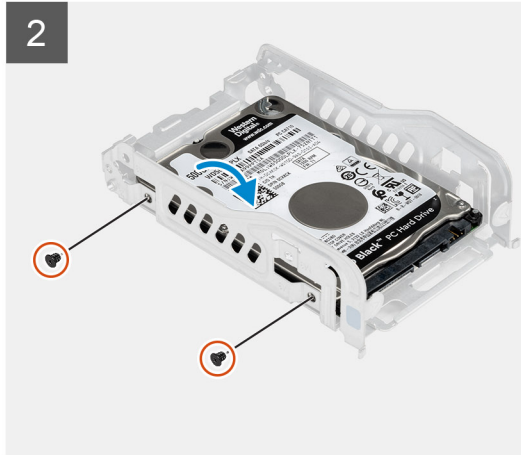

Steps

1. Place the first hard-disk drive into the hard-disk drive metal bracket and align the slots on the bracket with the slots on the hard-disk drive.
2. Replace the two (M3x3.5) screws to secure the first hard-disk drive to the hard-disk drive metal bracket.
3. Place the second hard-disk drive into the hard-disk drive metal bracket and align the slots on the bracket with the slots on the hard-disk drive.
4. Replace the two (M3x3.5) screws to secure the second hard-disk drive to the hard-disk drive metal bracket.

Next steps

1. Install the [2.5 in. hard-disk drive assembly](#).
2. Install the [fan duct](#).
3. Install the [side cover](#).
4. Follow the procedure in [after working inside your computer](#).

Installing the 2.5-inch hard-disk drive assembly

Prerequisites

If you are replacing a component, remove the existing component before performing the installation procedure.

About this task

The following image indicates the location of the 2.5-inch hard-disk drive assembly and provides a visual representation of the installation procedure.

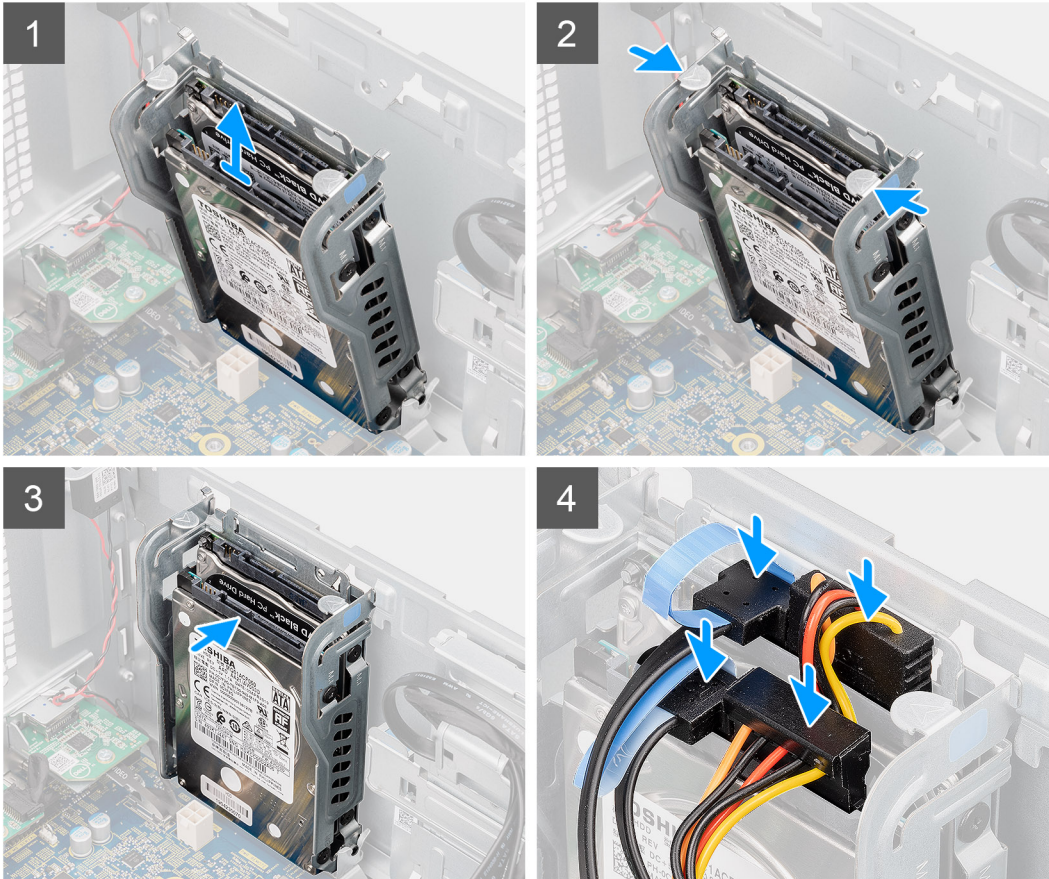
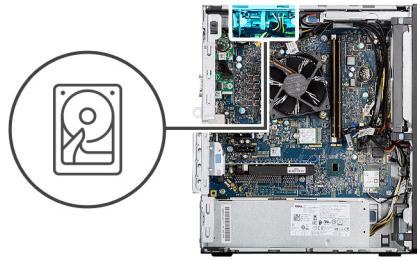

Steps

1. Align the hard-drive assembly at an angle to the slot on the computer.
2. Press the release tabs on the hard-disk drive bracket and slightly align back to insert the hard-disk drive assembly to the slot on the computer chassis.
3. Connect the hard-drive data and power cables to the connectors on the 2.5-inch hard-disk drive module.

Next steps

1. Install the [fan duct](#).
2. Install the [side cover](#).
3. Follow the procedure in [after working inside your computer](#).

3.5-inch hard drive

Removing the 3.5 inch hard drive

Prerequisites

1. Follow the procedure in [before working inside your computer](#).
2. Remove the [side cover](#).
3. Remove the [fan duct](#).

About this task

The following images indicate the location of the 3.5 inch hard drive and provides a visual representation of the removal procedure.



4x
#6-32

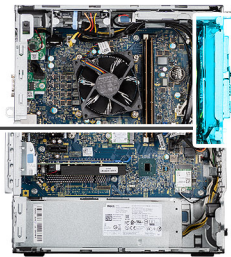

Steps

1. Disconnect the data and power cables from the 3.5 inch hard drive.
2. Remove the four (#6-32) screws from the front-side of the chassis that secures the hard drive to the chassis.
3. Remove the 3.5 inch hard drive away from the chassis.

Installing the 3.5 inch hard drive

Prerequisites

If you are replacing a component, remove the existing component before performing the installation procedure.

About this task

The following images indicate the location of the 3.5-inch hard drive and provides a visual representation of the installation procedure.



4x
#6-32

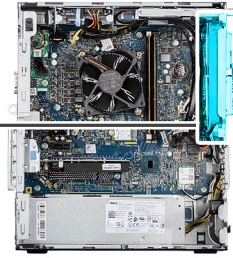

Steps

1. Align and insert the 3.5 inch hard drive into the slot on the chassis.
2. Hold the hard drive against the chassis and replace the four (#6-32) screws to secure the hard drive to the computer chassis.
3. Connect the power cable and data cable to the hard drive.

Next steps

1. Install the [fan duct](#).
2. Install the [side cover](#).
3. Follow the procedure in [after working inside your computer](#).

Solid-state drive

Removing the M.2 2230 PCIe solid-state drive

Prerequisites

1. Follow the procedure in [before working inside your computer](#).
2. Remove the [side cover](#).
3. Remove the [fan duct](#).

About this task

The following images indicate the location of the solid-state drive and provide a visual representation of the removal procedure.



1x
M2x3.5

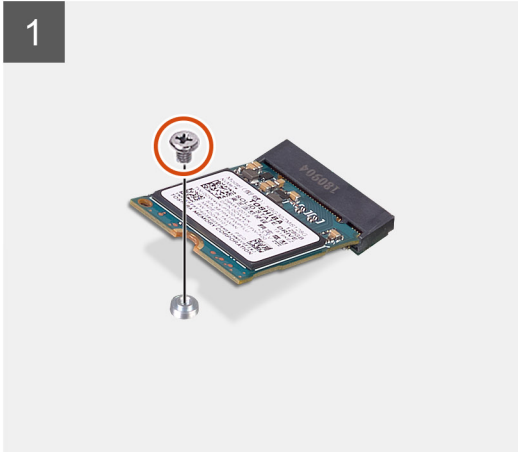
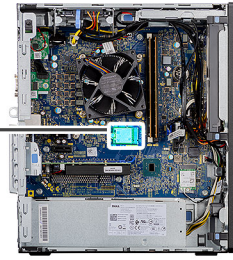

Steps

1. Remove the screw (M2x3.5) that secures the solid-state drive to the system board.
2. Slide and lift the solid-state drive off the system board.

Installing the M.2 2230 PCIe solid-state drive

Prerequisites

If you are replacing a component, remove the existing component before performing the installation procedure.

About this task

The following image indicates the location of the solid-state drive and provides a visual representation of the installation procedure.



1x
M2x3.5

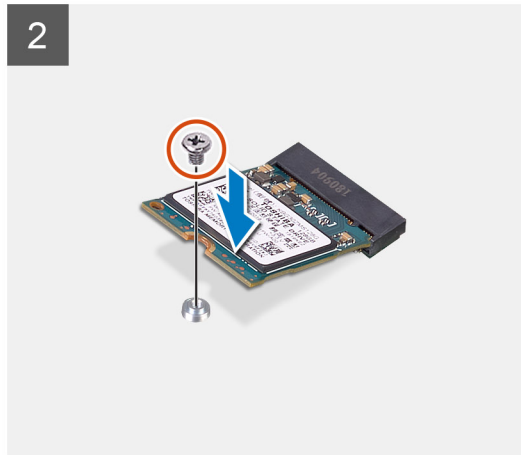
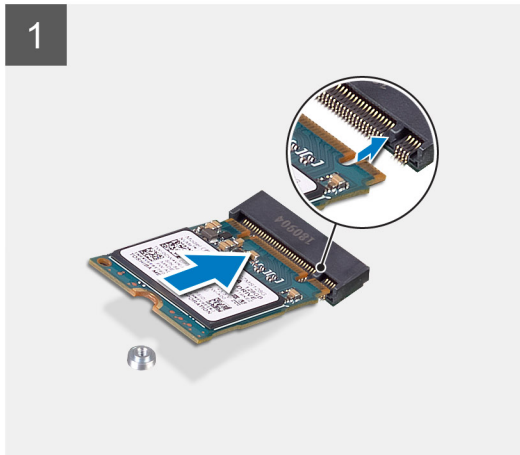
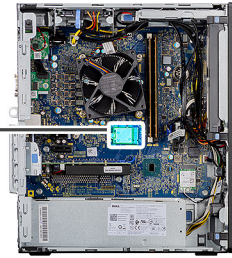

Steps

1. Align the notch on the solid-state drive with the tab on the solid-state drive connector.
2. Insert the solid-state drive at a 45-degree angle into the slot on the system board.
3. Replace the screw (M2x3.5) to secure the M.2 2230 solid-state drive to the system board.

Next steps

1. Install the [fan duct](#).
2. Install the [side cover](#).
3. Follow the procedure in [after working inside your computer](#).

Removing the M.2 2280 PCIe solid-state drive

Prerequisites

1. Follow the procedure in [before working inside your computer](#).
2. Remove the [side cover](#).
3. Remove the [fan duct](#).

About this task

The following images indicate the location of the solid-state drive and provide a visual representation of the removal procedure.



1x
M2x3.5

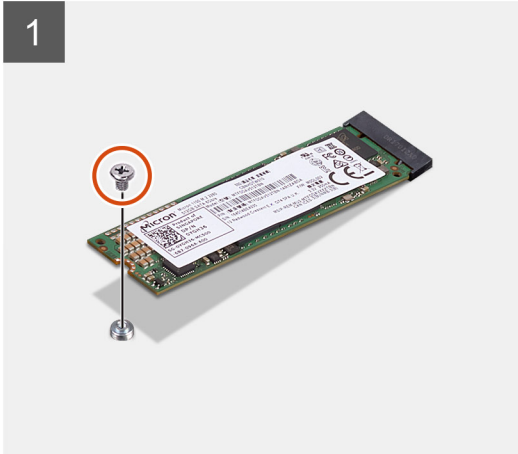
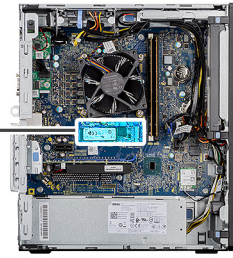

Steps

1. Remove the screw (M2x3.5) that secures the solid-state drive to the system board.
2. Slide and lift the solid-state drive off the system board.

Installing the M.2 2280 PCIe solid-state drive

Prerequisites

If you are replacing a component, remove the existing component before performing the installation procedure.

About this task

The following image indicates the location of the solid-state drive and provides a visual representation of the installation procedure.



1x
M2x3.5

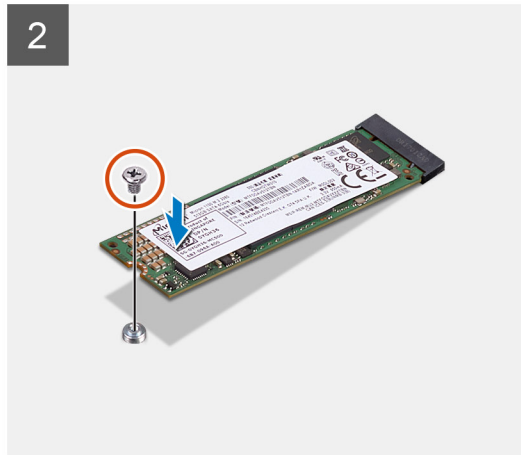
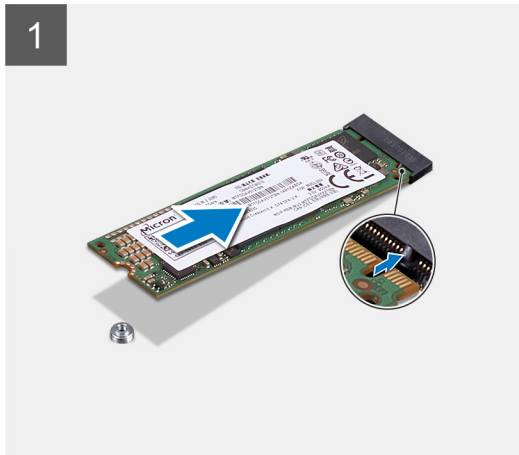
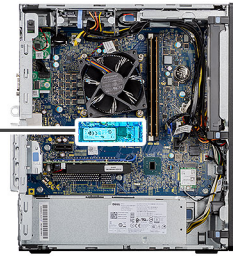

Steps

1. Align the notch on the solid-state drive with the tab on the solid-state drive connector.
2. Insert the solid-state drive at a 45-degree angle into the slot on the system board.
3. Replace the screw (M2x3.5) to secure the M.2 2280 solid-state drive to the system board.

Next steps

1. Install the [fan duct](#).
2. Install the [side cover](#).
3. Follow the procedure in [after working inside your computer](#).

Memory modules

Removing the memory modules

Prerequisites

1. Follow the procedure in [before working inside your computer](#).
2. Remove the [side cover](#).
3. Remove the [fan duct](#).

About this task

The following images indicate the location of the memory modules and provide a visual representation of the removal procedure.

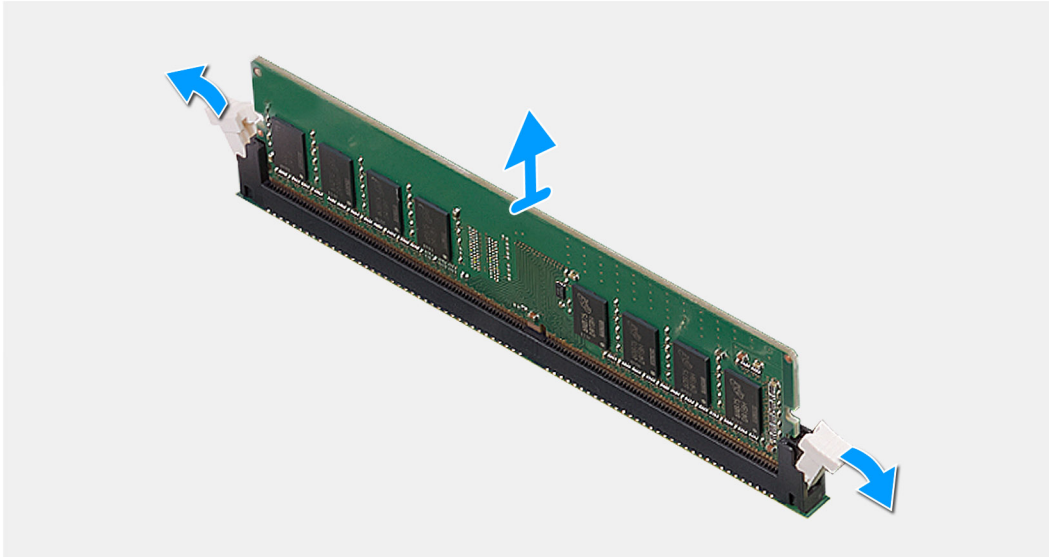
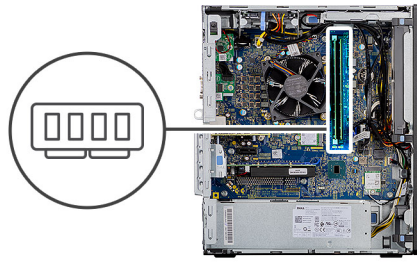

Steps

1. Pull the securing clips from both side of the memory module until the memory module pops up.
2. Slide and remove the memory module from the memory-module slot.

Installing the memory modules

Prerequisites

If you are replacing a component, remove the existing component before performing the installation procedure.

About this task

The following image indicates the location of the memory modules and provides a visual representation of the installation procedure.

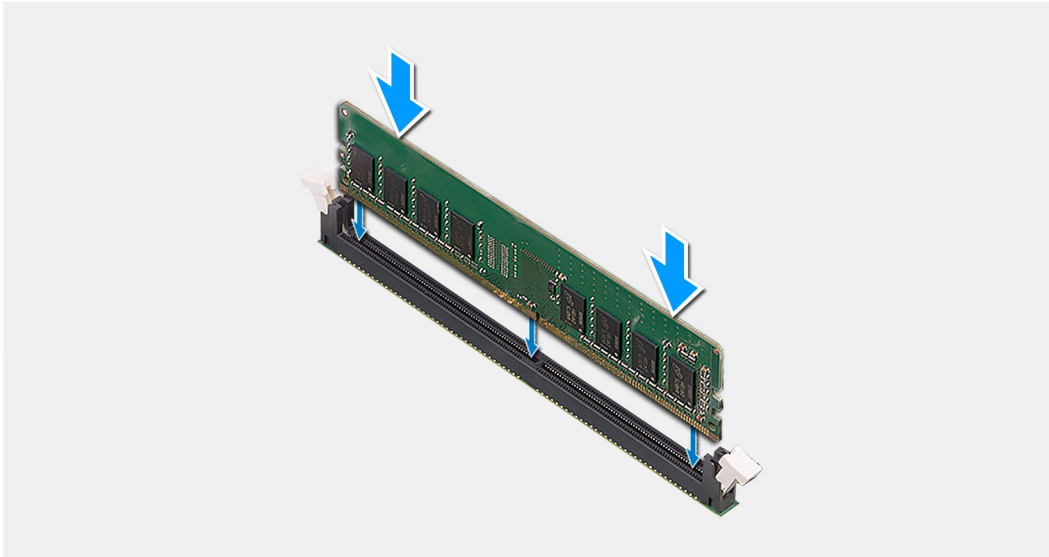
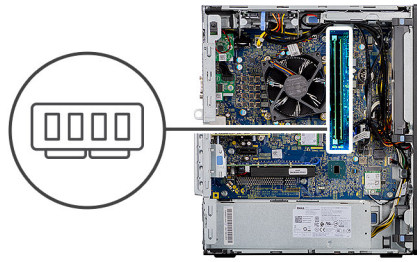

Steps

1. Align the notch on the memory module with the tab on the memory-module slot.
2. Slide the memory module firmly into the slot at an angle and press the memory module down until it clicks into place.

i **NOTE:** If you do not hear the click, remove the memory module and reinstall it.

Next steps

1. Install the [fan duct](#).
2. Install the [side cover](#).
3. Follow the procedure in [after working inside your computer](#).

Processor fan and heat-sink assembly

Removing the processor fan and heat-sink assembly

Prerequisites

1. Follow the procedure in [before working inside your computer](#).

⚠ **WARNING:** The heat sink may become hot during normal operation. Allow sufficient time for the heat sink to cool before you touch it.

⚠ **CAUTION:** For maximum cooling of the processor, do not touch the heat transfer areas on the heat sink. The oils in your skin can reduce the heat transfer capability of the thermal grease.

2. Remove the [side cover](#).
3. Remove the [fan duct](#).

About this task

The following images indicate the location of the processor fan and heat-sink and provide a visual representation of the removal procedure.

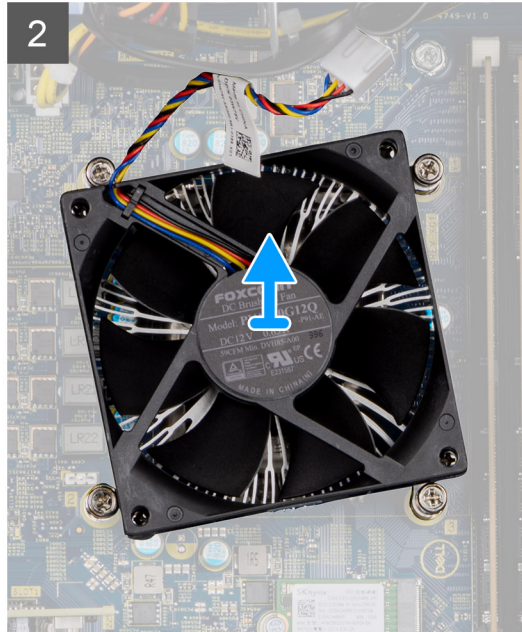
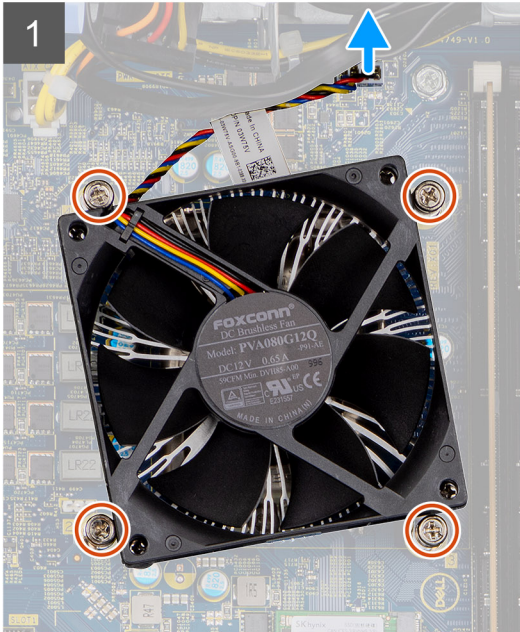
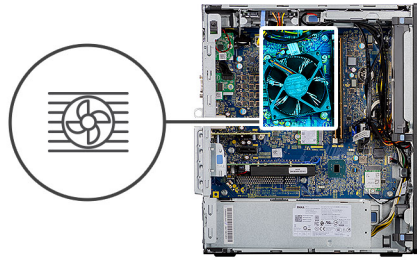

Steps

1. Disconnect the processor fan cable from the connector on the system board.
2. Loosen the four captive screws that secure the processor fan and heat-sink assembly to the system board.
3. Lift the processor fan and heat-sink assembly off the system board.

Installing the processor fan and heat-sink assembly

Prerequisites

NOTE: If either the processor or the heat sink is replaced, use the thermal grease provided in the kit to ensure that thermal conductivity is achieved.

About this task

The following image indicates the location of the processor fan and heat-sink assembly and provides a visual representation of the installation procedure.

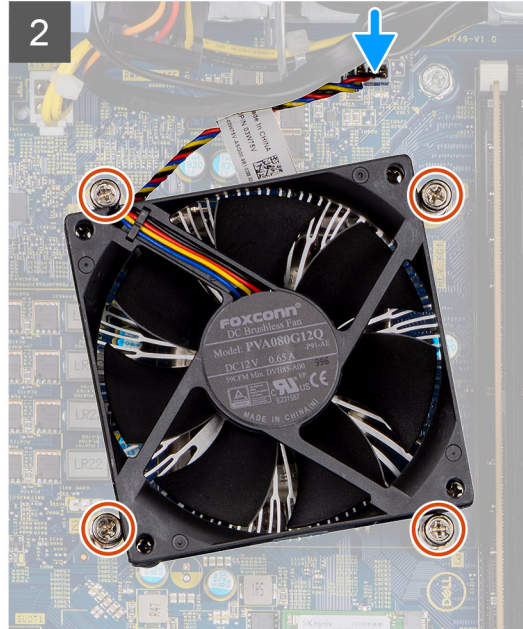
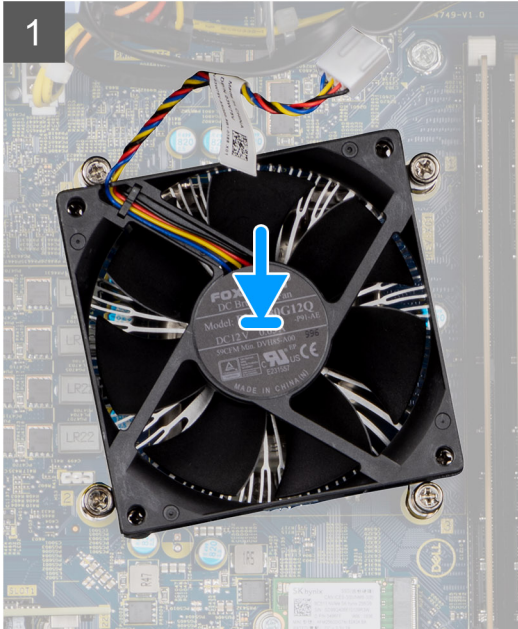
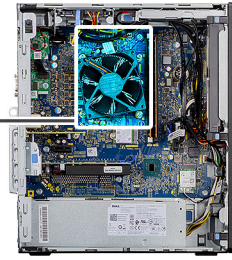

Steps

1. Align the screw holes on the processor fan and heat-sink assembly with the screw holes on the system board.
2. Tighten the four captive screws that secure the processor fan and heat-sink assembly to the system board.
3. Connect the processor-fan cable to the connector on the system board.

Next steps

1. Install the [fan duct](#).
2. Install the [side cover](#).
3. Follow the procedure in [after working inside your computer](#).

Processor

Removing the processor

Prerequisites

1. Follow the procedure in [before working inside your computer](#).
2. Remove the [side cover](#).
3. Remove the [fan duct](#).
4. Remove the [processor fan and heat-sink assembly](#).

NOTE: The processor might still be hot after the computer is shut down. Allow the processor to cool down before removing it.

About this task

The following images indicate the location of the processor and provide a visual representation of the removal procedure.

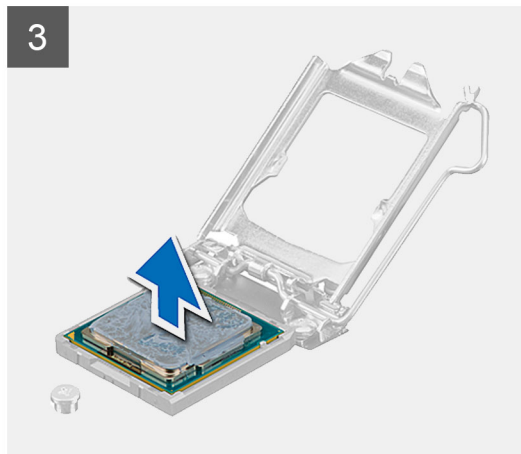
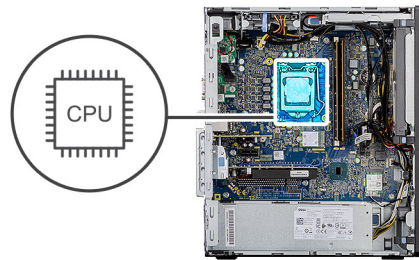

Steps

1. Press down and push the release lever away from the processor to release it from the securing tab.
2. Lift the lever upward to lift the processor cover.

CAUTION: When removing the processor, do not touch any of the pins inside the socket or allow any objects to fall on the pins in the socket.

3. Gently lift the processor from the processor socket.

Installing the processor

Prerequisites

If you are replacing a component, remove the existing component before performing the installation procedure.

About this task

The following image indicates the location of the processor and provides a visual representation of the installation procedure.

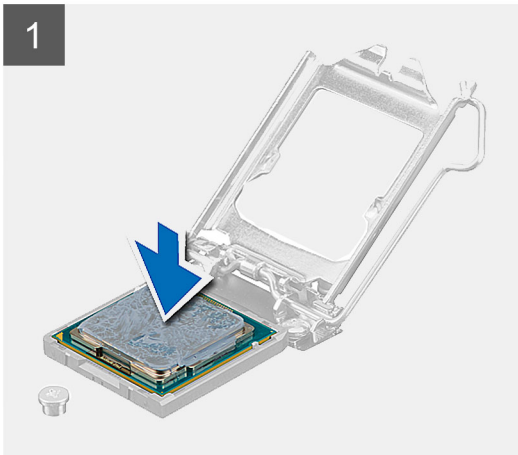
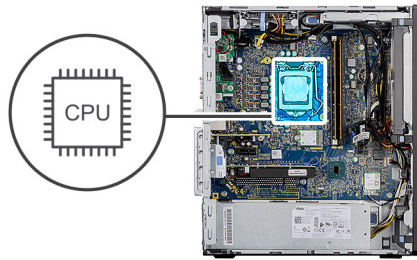

Steps

1. Ensure that the release lever on the processor socket is fully extended in the open position.
2. Align the notches on the processor with the tabs on the processor socket and place the processor in the processor socket.
i NOTE: The pin-1 corner of the processor has a triangle that aligns with the triangle on the pin-1 corner on the processor socket. When the processor is properly seated, all four corners are aligned at the same height. If one or more corners of the processor are higher than the others, the processor is not seated properly.
3. When the processor is fully seated in the socket, pivot the release-lever down and place it under the tab on the processor cover.

Next steps

1. Install the [processor fan and heat-sink assembly](#).
2. Install the [fan duct](#).
3. Install the [side cover](#).
4. Follow the procedure in [after working inside your computer](#).

Graphics card

Removing the graphics card

Prerequisites

1. Follow the procedure in [before working inside your computer](#).
2. Remove the [side cover](#).
3. Remove the [fan duct](#).

About this task

The following images indicate the location of the graphics card and provides a visual representation of the removal procedure.

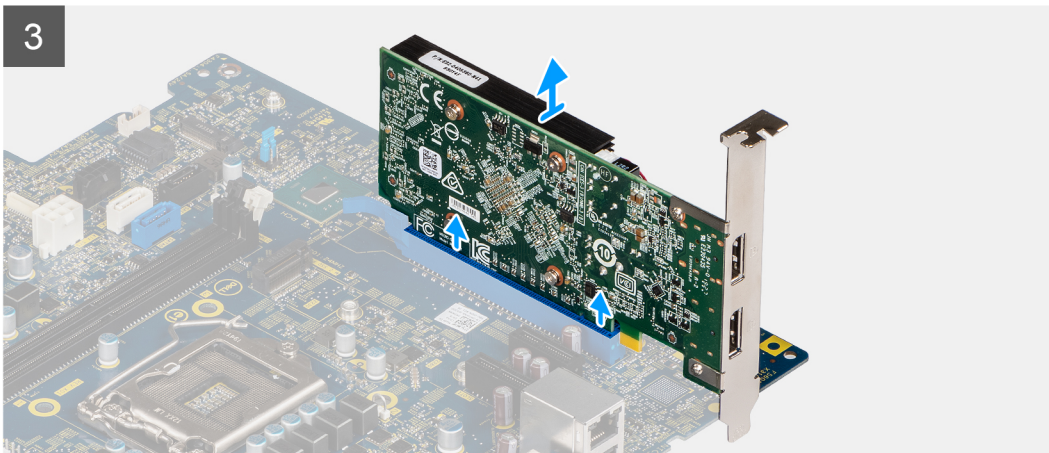
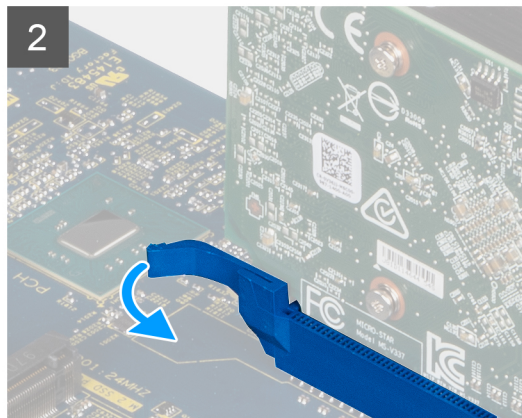
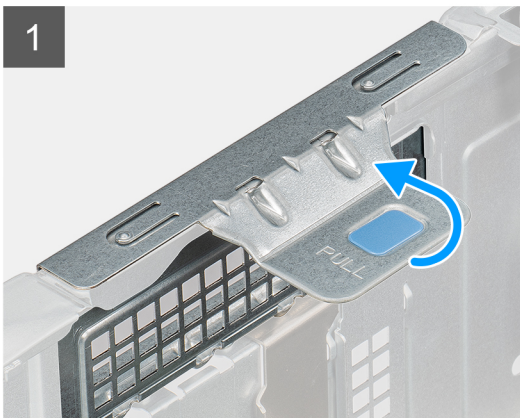
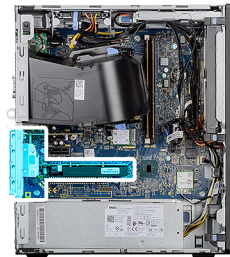

Steps

1. Locate the graphics card (PCI-Express).
2. Lift the pull tab to open the PCIe door.
3. Push and hold the securing tab on the graphics-card slot and lift the graphics card from the graphics-card slot.

Installing the graphics card

Prerequisites

If you are replacing a component, remove the existing component before performing the installation procedure.

About this task

The following images indicate the location of the graphics card and provides a visual representation of the installation procedure.

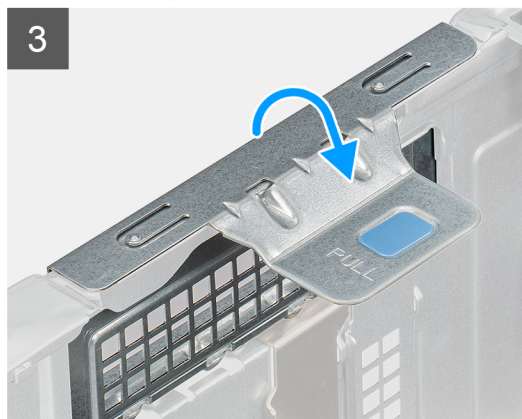
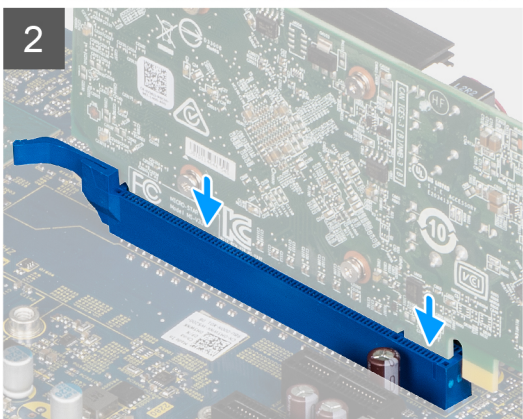
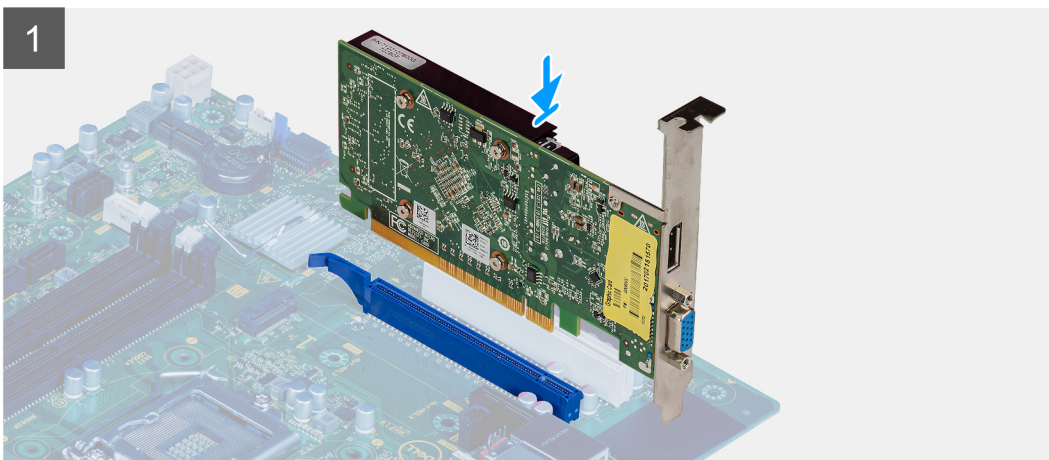

Steps

1. Align the graphics card with the PCI-Express card connector on the system board.
2. Using the alignment post, connect the graphics card in the connector and press down firmly. Ensure that the card is firmly seated.
3. Lift the pull tab to close the PCIe door.

Next steps

1. Install the [fan duct](#).
2. Install the [side cover](#).
3. Follow the procedure in [after working inside your computer](#).

Graphical processing unit

Removing the powered GPU

Prerequisites

1. Follow the procedure in [before working inside your computer](#).
2. Remove the [side cover](#).
3. Remove the [fan duct](#).

About this task

The following images indicate the location of the powered graphical processing unit and provides a visual representation of the removal procedure.

Steps

1. Disconnect the two power cables from the connectors on the powered GPU.
2. Lift the pull tab to open the PCIe door.
3. Push and hold the securing tab on the graphics-card slot and lift the powered GPU away from the graphics-card slot.

Installing the powered GPU

Prerequisites

If you are replacing a component, remove the existing component before performing the installation procedure.

About this task

The following images indicate the location of the powered graphical processing unit and provides a visual representation of the installation procedure.

Steps

1. Align the powered GPU with the PCI-Express card connector on the system board.
2. Using the alignment post, connect the powered GPU in the connector and press down firmly. Ensure that the powered GPU is firmly seated.
3. Lift the pull tab to close the PCIe door.
4. Connect the two power cables to the connector on the powered GPU.

Next steps

1. Install the [fan duct](#).
2. Install the [side cover](#).
3. Follow the procedure in [after working inside your computer](#).

Coin-cell battery

Removing the coin-cell battery

Prerequisites

1. Follow the procedure in [before working inside your computer](#).
2. Remove the [side cover](#).
3. Remove the [fan duct](#).
4. Remove the [powered GPU](#).

NOTE: This step is required only if the system is configured with powered GPU.

About this task

The following images indicate the location of the coin-cell battery and provide a visual representation of the removal procedure.

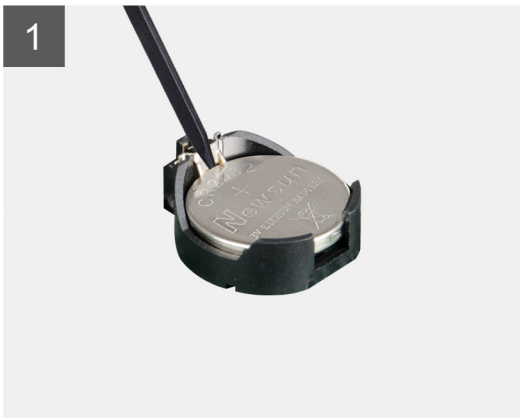
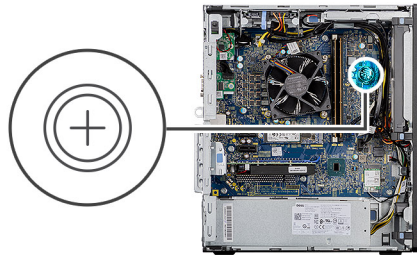

Steps

1. Using a plastic scribe, gently pry the coin-cell battery out of the slot on the system board.
2. Remove the coin-cell battery away from the computer.

Installing the coin-cell battery

Prerequisites

If you are replacing a component, remove the existing component before performing the installation procedure.

About this task

The following image indicates the location of the coin-cell battery and provides a visual representation of the installation procedure.

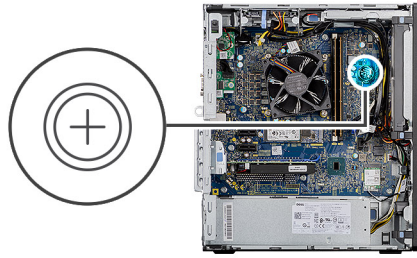

Steps

1. Insert the coin cell battery with the "+" sign facing up and slide it under the securing tabs at the positive side of the connector.
2. Press the battery into the connector until it locks into place.

Next steps

1. Install the [powered GPU](#).
i **NOTE:** This step is required only if the system is configured with powered GPU.
2. Install the [fan duct](#).
3. Install the [side cover](#).
4. Follow the procedure in [after working inside your computer](#).

WLAN card

Removing the WLAN card

Prerequisites

1. Follow the procedure in [before working inside your computer](#).
2. Remove the [side cover](#).
3. Remove the [fan duct](#).
4. Remove the [powered GPU](#).
i **NOTE:** This step is required only if the system is configured with powered GPU.

About this task

The following images indicate the location of the wireless card and provide a visual representation of the removal procedure.



1x
M2x3.5

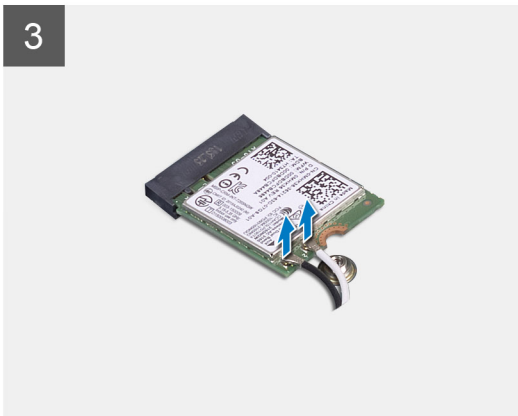
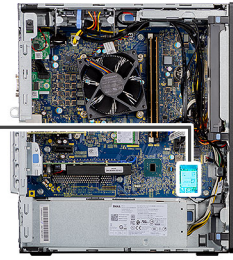

Steps

1. Remove the (M2x3.5) screw that secures the WLAN card to the system board.
2. Lift the WLAN card bracket away from the WLAN card.
3. Disconnect the antenna cables from the WLAN card.
4. Slide and remove the WLAN card from the connector on the system board.

Installing the WLAN card

Prerequisites

If you are replacing a component, remove the existing component before performing the installation procedure.

About this task

The following image indicates the location of the wireless card and provides a visual representation of the installation procedure.



1x
M2x3.5

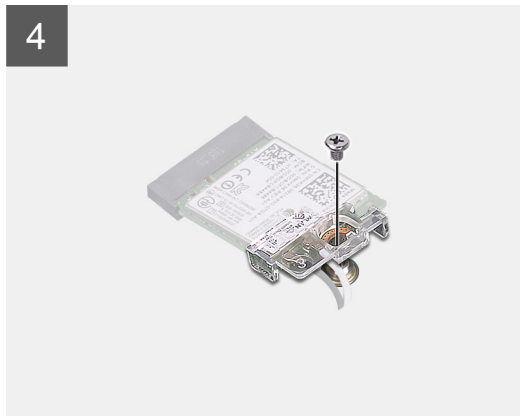
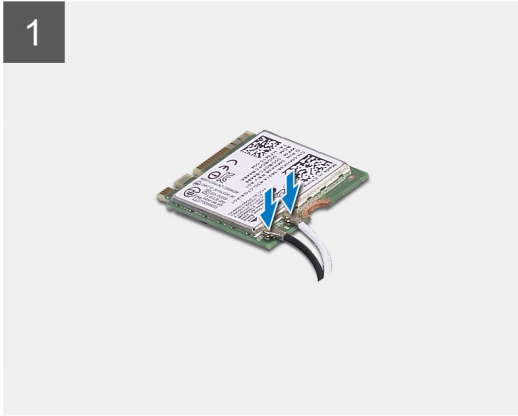
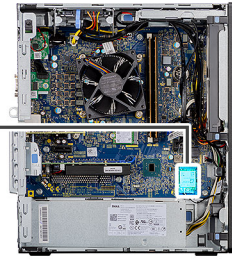

Steps

1. Connect the antenna cables to the WLAN card.
The following table provides the antenna-cable color scheme for the WLAN card of your computer.

Table 6. Antenna-cable color scheme

Connectors on the wireless card	Antenna-cable color
Main (white triangle)	White
Auxiliary (black triangle)	Black

2. Place the WLAN card bracket to secure the WLAN antenna cables.
3. Insert the WLAN card into the connector on the system board.
4. Replace the (M2x3.5) screw to secure the plastic tab to the WLAN card.

Next steps

1. Install the [powered GPU](#).
 **NOTE:** This step is required only if the system is configured with powered GPU.
2. Install the [fan duct](#).
3. Install the [side cover](#).
4. Follow the procedure in [after working inside your computer](#).

Slim optical-drive

Removing the Slim-Optical Disk Drive

Prerequisites

1. Follow the procedure in [before working inside your computer](#).
2. Remove the [side cover](#).
3. Remove the [fan duct](#).

About this task

The following images indicate the location of the slim ODD and provides a visual representation of the removal procedure.

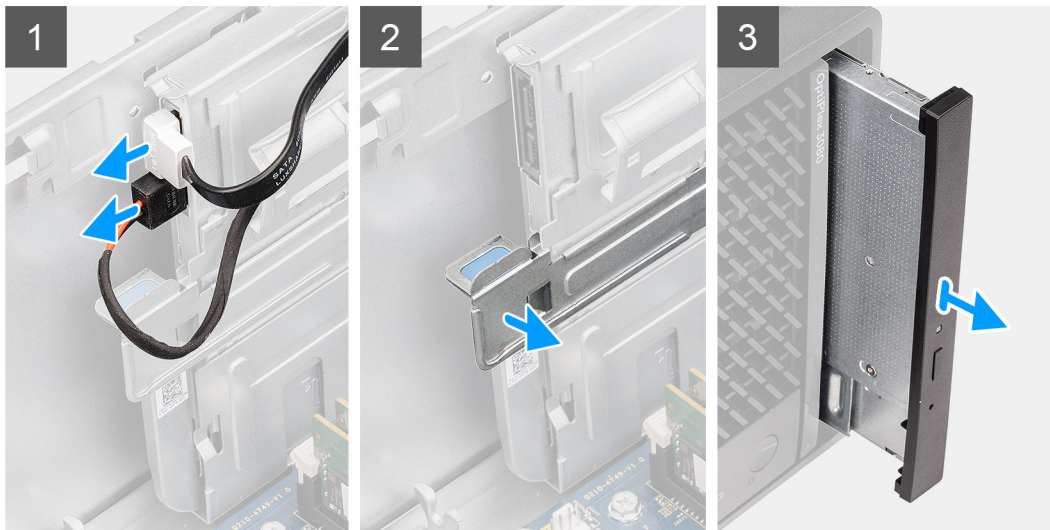
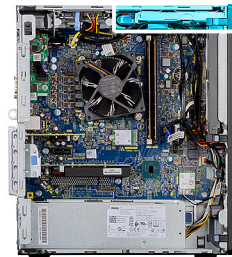

Steps

1. Disconnect the data and power cables from the slim ODD.
2. Pull the securing tab to release the slim ODD from the chassis.
3. Slide and remove the slim ODD from the ODD slot.

Installing the Slim-Optical Disk Drive

Prerequisites

If you are replacing a component, remove the existing component before performing the installation procedure.

About this task

The following images indicate the location of the slim ODD and provide a visual representation of the installation procedure.

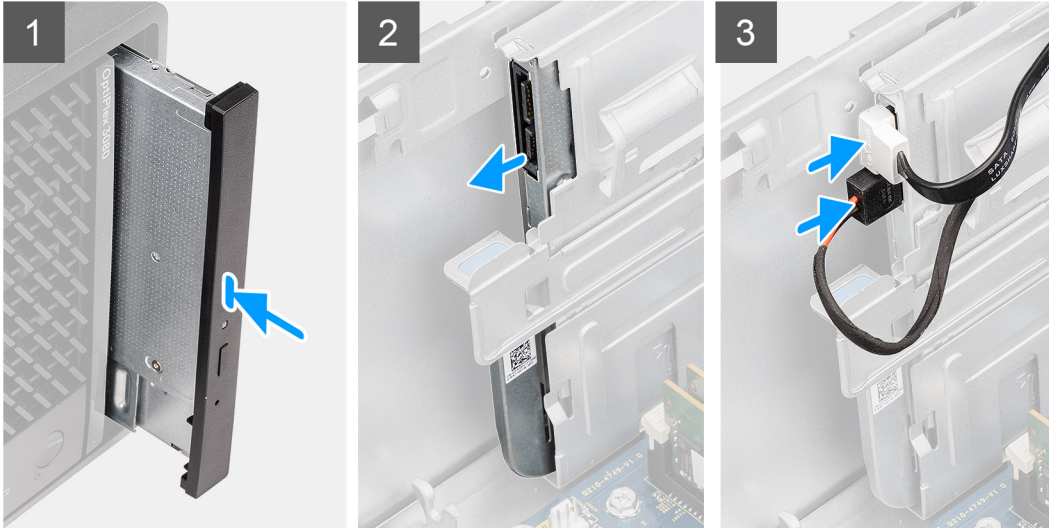
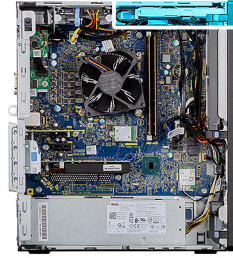

Steps

1. Insert the slim ODD assembly into the ODD slot.
2. Slide the slim ODD assembly until it snaps into place.
3. Route the power cable and data cable through the routing guides and connect the cables to the slim ODD.

Next steps

1. Install the [fan duct](#).
2. Install the [side cover](#).
3. Follow the procedure in [after working inside your computer](#).

Slim optical-drive bracket

Removing the slim-ODD bracket

Prerequisites

1. Follow the procedure in [before working inside your computer](#).
2. Remove the [side cover](#).
3. Remove the [fan duct](#).
4. Remove the [slim Optical Disk Drive](#).

About this task

The following images indicate the location of the slim-ODD bracket and provides a visual representation of the removal procedure.



Steps

1. Pry the slim-ODD bracket to release it from the slot on the ODD.
2. Remove the slim-ODD bracket off the ODD.

Installing the slim-ODD bracket

Prerequisites

If you are replacing a component, remove the existing component before performing the installation procedure.

About this task

The following images indicate the location of the slim-ODD bracket and provides a visual representation of the installation procedure.



Steps

1. Align and place the slim-ODD bracket on the ODD slots.
2. Snap the slim-ODD bracket into the slim ODD.

Next steps

1. Install the [slim Optical Disk Drive](#).
2. Install the [fan duct](#).
3. Install the [side cover](#).

4. Follow the procedure in [after working inside your computer](#).

Speaker

Removing the speaker

Prerequisites

1. Follow the procedure in [before working inside your computer](#).
2. Remove the [side cover](#).
3. Remove the [fan duct](#).

About this task

The following images indicate the location of the speakers and provide a visual representation of the removal procedure.

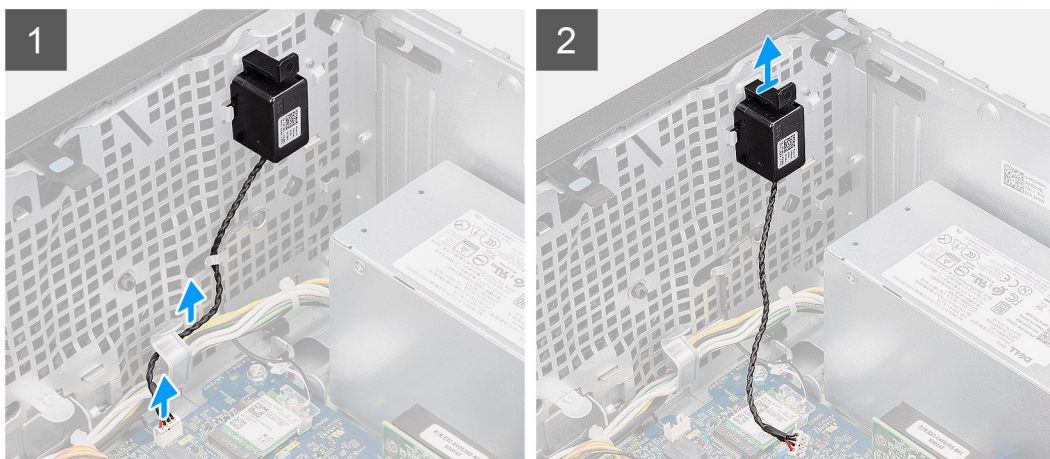

Steps

1. Disconnect the speaker cable from the connector on the system board.
2. Unroute the speaker cable from the routing guides on the chassis.
3. Press the tab and slide the speaker along with the cable from the slot on the chassis.

Installing the speaker

Prerequisites

If you are replacing a component, remove the existing component before performing the installation procedure.

About this task

The following image indicates the location of the speaker and provides a visual representation of the installation procedure.

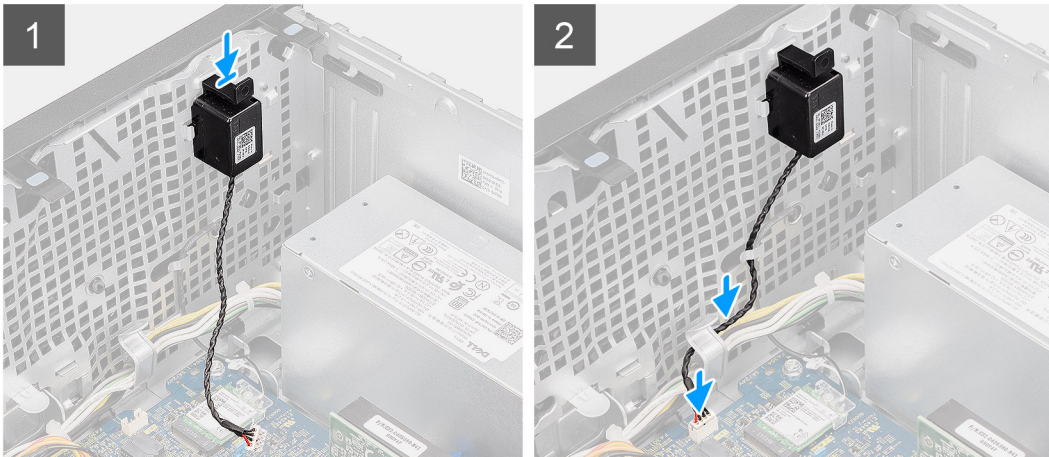
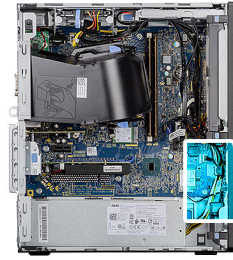

Steps

1. Press and slide the speaker in the slot on the chassis until it snaps into place.
2. Route the speaker cable through the routing guide on the chassis.
3. Connect the speaker cable to the connector on the system board.

Next steps

1. Install the [fan duct](#).
2. Install the [side cover](#).
3. Follow the procedure in [after working inside your computer](#).

Power button

Removing the power button

Prerequisites

1. Follow the procedure in [before working inside your computer](#).
2. Remove the [side cover](#).
3. Remove the [fan duct](#).
4. Remove the [front bezel](#).

About this task

The following images indicate the location of the power button and provides a visual representation of the removal procedure.

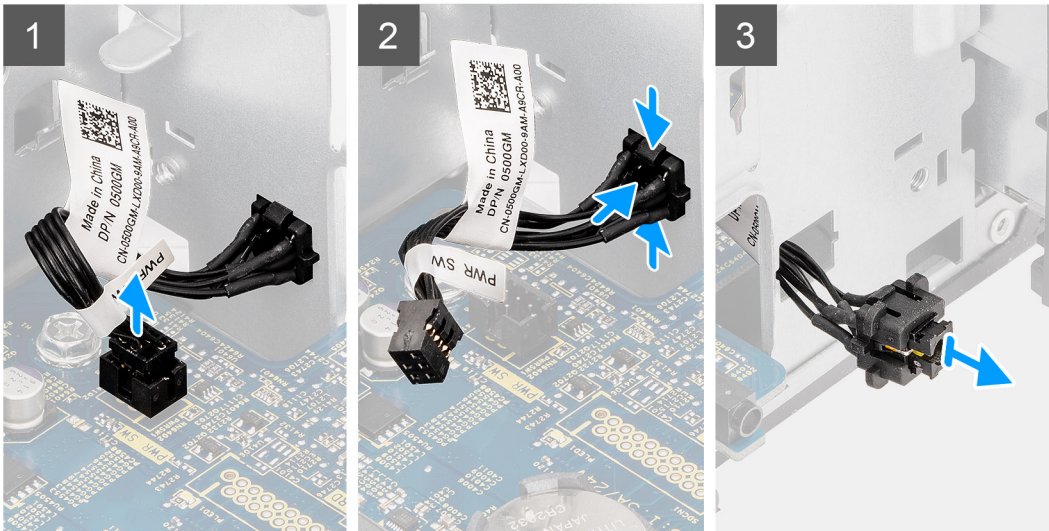
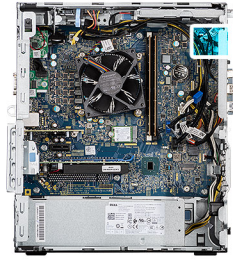

Steps

1. Disconnect the power-button cable from the connector on the system board.
2. Press the release tabs on the power-button head and slide the power-button cable out from the front-side chassis of the computer.
3. Pull the power-button cable out from the computer.

Installing the power button

Prerequisites

If you are replacing a component, remove the existing component before performing the installation procedure.

About this task

The following images indicate the location of the power button switch and provides a visual representation of the installation procedure.

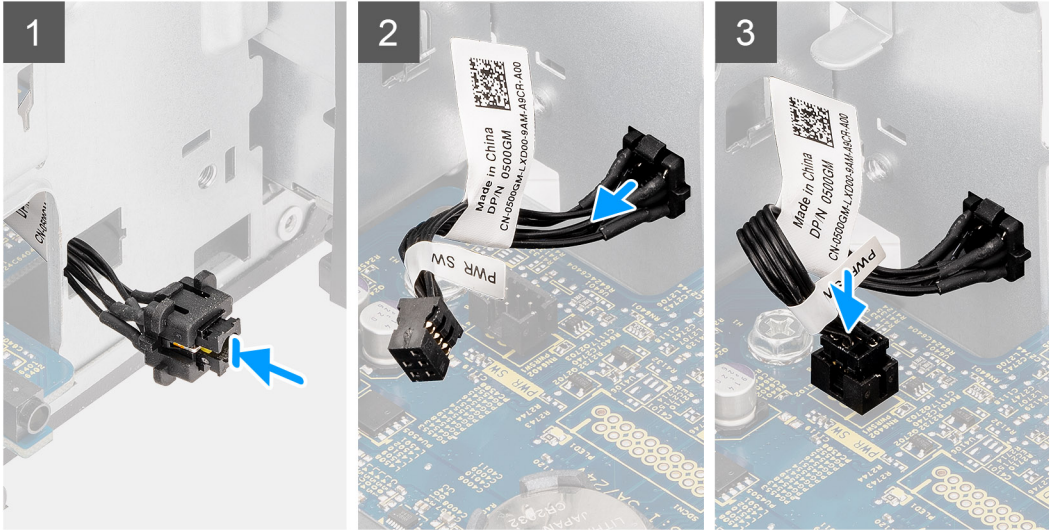
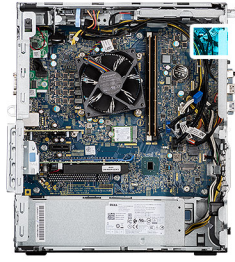

Steps

1. Insert the power-button cable into the slot from the front-side of the computer, and press the power-button head until it clicks into the place in the chassis.
2. Align and connect the power-button cable to the connector on the system board.

Next steps

1. Install the [front bezel](#).
2. Install the [fan duct](#).
3. Install the [side cover](#).
4. Follow the procedure in [after working inside your computer](#).

Power-supply unit

Removing the power-supply unit

Prerequisites

1. Follow the procedure in [before working inside your computer](#).
2. Remove the [side cover](#).
3. Remove the [fan duct](#).

i **NOTE:** Note the routing of all cables as you remove them so that you can route them correctly while you are replacing the power-supply unit.

About this task

The following images indicate the location of the power-supply unit and provides a visual representation of the removal procedure.



3x
#6-32

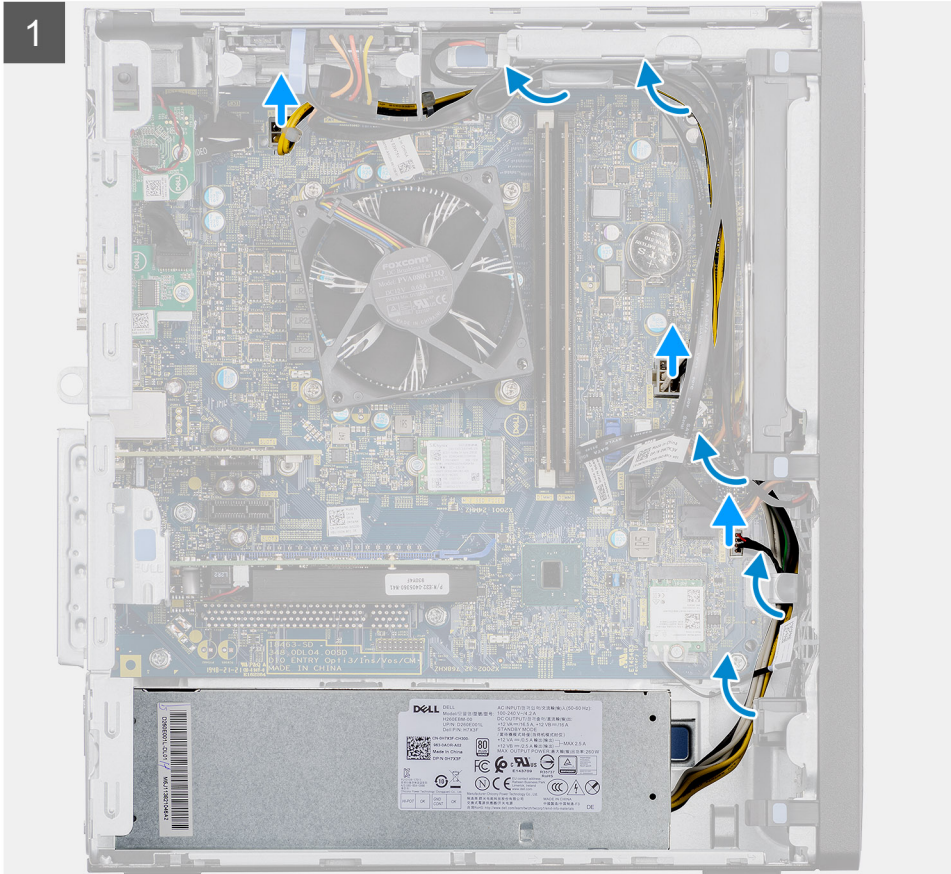
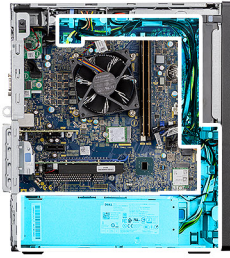

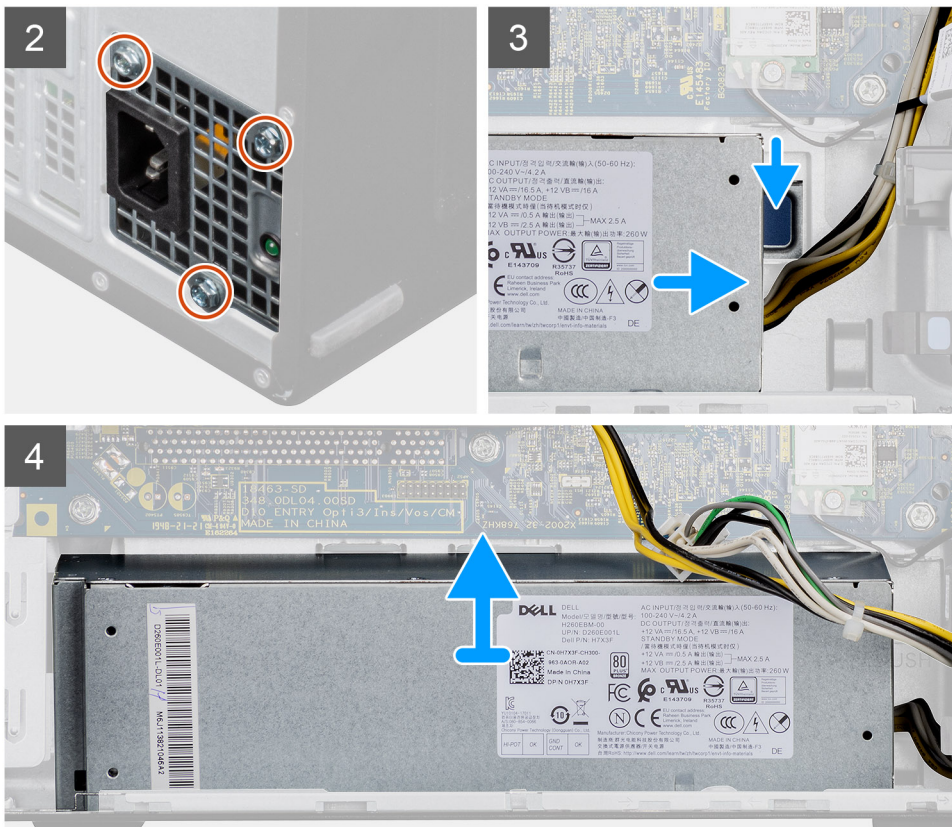

Steps

1. Lay the computer on the right side.
2. Disconnect the power cables from the system board and unroute them from the routing guides on the chassis.
3. Remove the three (#6-32) screws that secure the power-supply unit to the chassis.
4. Press the securing clip and slide the power-supply unit away from the back of the chassis.
5. Lift the power-supply unit off the chassis.

Installing the power-supply unit

Prerequisites

If you are replacing a component, remove the existing component before performing the installation procedure.

⚠ WARNING: The cables and ports on the back of the power-supply unit are color-coded to indicate the different power wattage. Ensure that you plug in the cable to the correct port. Failure to do so may result in damaging the power-supply unit and/or system components.

About this task

The following images indicate the location of the power-supply unit and provides a visual representation of the installation procedure.



3x
#6-32

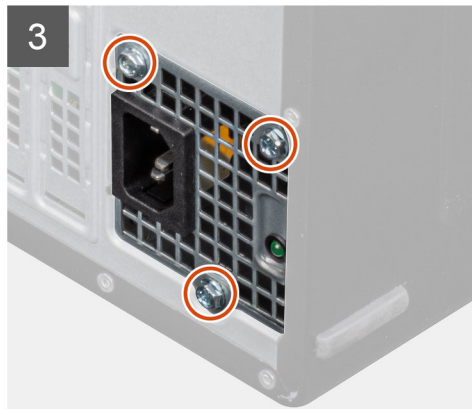
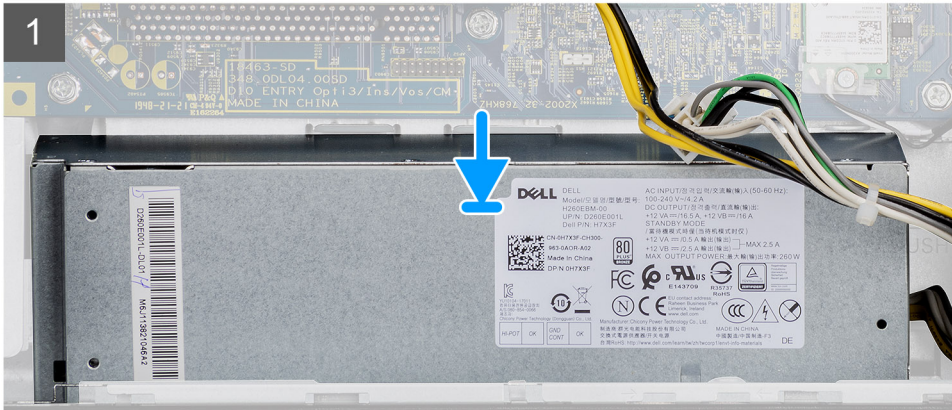
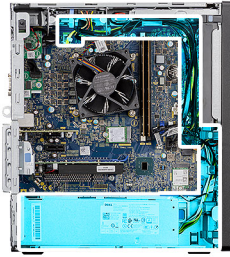



Steps

1. Slide the power-supply unit into the chassis until the securing tab snaps into position.
2. Replace the three (#6-32) screws to secure the power-supply unit to the chassis.
3. Route the power cable through the routing guides on the chassis and connect the power cables to their respective connectors on the system board.

Next steps

1. Install the [fan duct](#).
2. Install the [side cover](#).
3. Follow the procedure in [after working inside your computer](#).

Intrusion switch

Removing the intrusion switch

Prerequisites

1. Follow the procedure in [before working inside your computer](#).
2. Remove the [side cover](#).
3. Remove the [fan duct](#).

About this task

The following images indicate the location of the intrusion switch and provides a visual representation of the removal procedure.

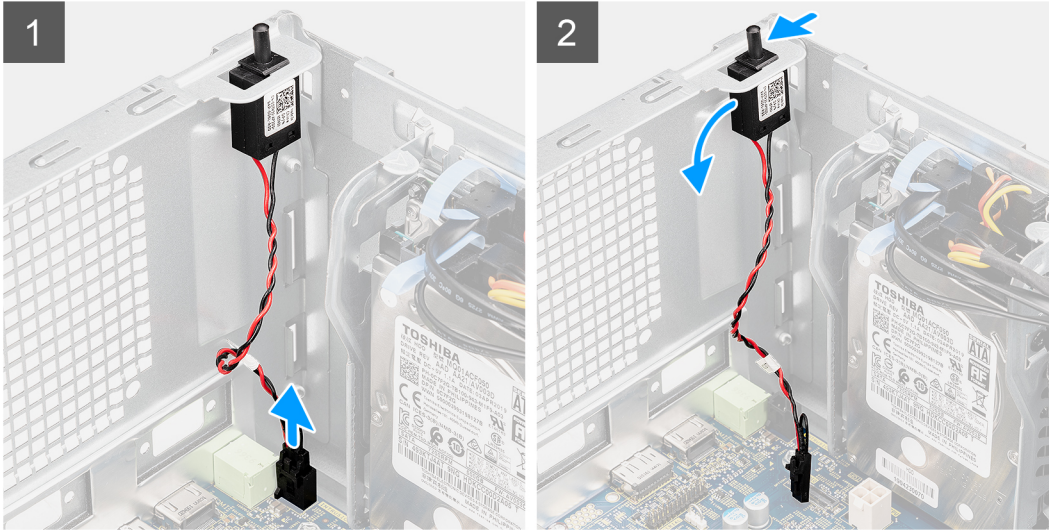
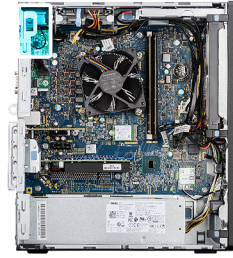

Steps

1. Disconnect the intruder cable from the connector on the system board.
2. Slide and remove the intrusion switch from the chassis.

Installing the intrusion switch

Prerequisites

If you are replacing a component, remove the existing component before performing the installation procedure.

About this task

The following images indicate the location of the intrusion switch and provides a visual representation of the installation procedure.

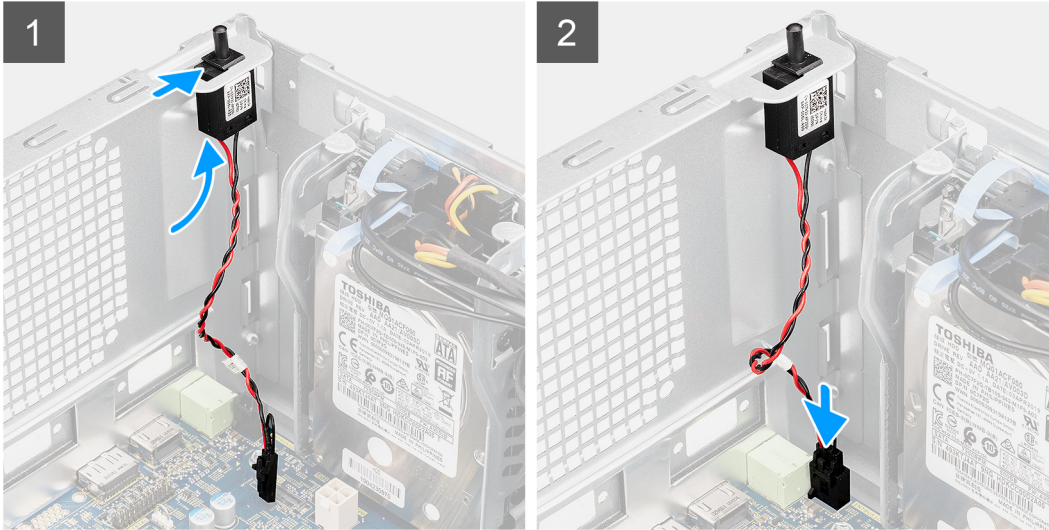
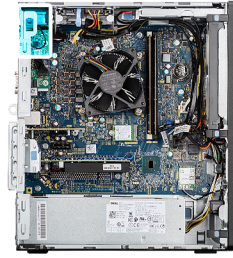

Steps

1. Insert the intrusion switch into its slot and slide the switch to secure it into the slot.
2. Connect the intruder cable to the connector on the system board.

Next steps

1. Install the [fan duct](#).
2. Install the [side cover](#).
3. Follow the procedure in [after working inside your computer](#).

Optional I/O modules (Type C/ HDMI/VGA/DP/Serial)

Removing optional I/O modules (Type C/ HDMI/VGA/DP/Serial)

Prerequisites

1. Follow the procedure in [before working inside your computer](#).
2. Remove the [side cover](#).
3. Remove the [front bezel](#).
4. Remove the [fan duct](#).

About this task

The following images indicate the location of the optional I/O Modules and provides a visual representation of the removal procedure.

Steps

1. Remove the two (M3X3) screws that secure the optional i/O module to the computer chassis.
2. Disconnect the I/O-module cable from the connector on the system board.

3. Remove the I/O module from the computer.

Installing optional I/O modules (Type-C/HDMI/VGA/DP/Serial)

Prerequisites

If you are replacing a component, remove the existing component before performing the installation procedure.

About this task

The following images indicate the location of the system board and provides a visual representation of the installation procedure.

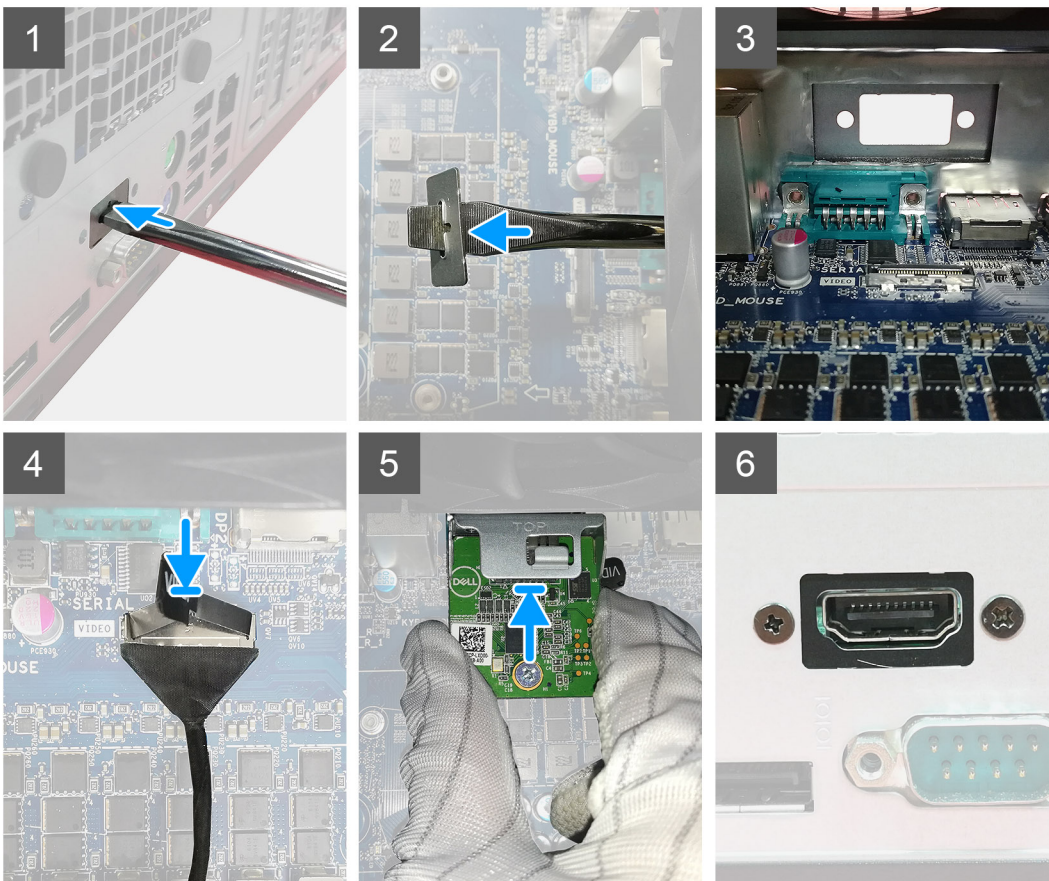

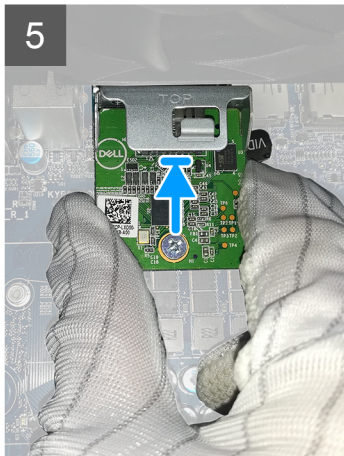
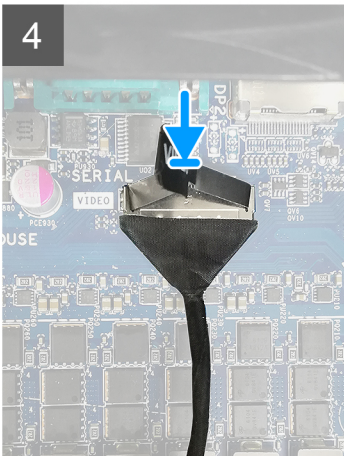
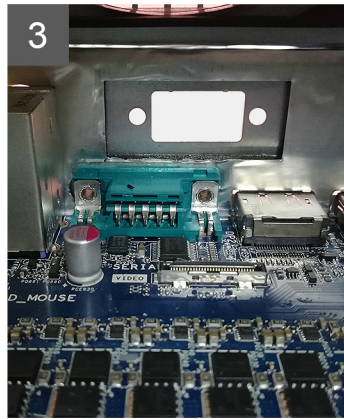
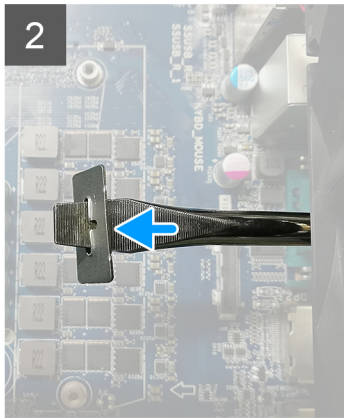
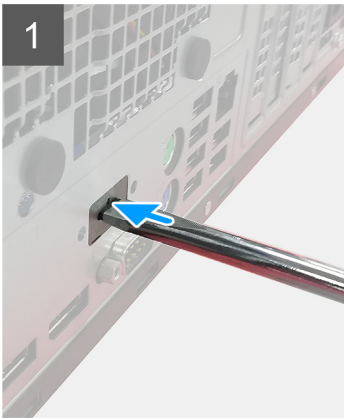

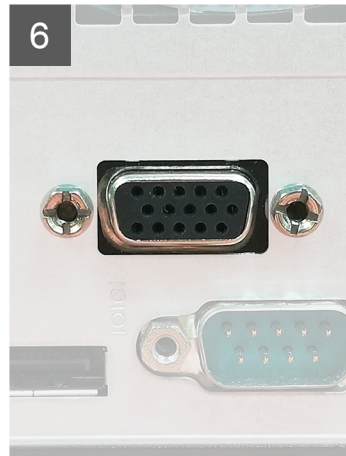
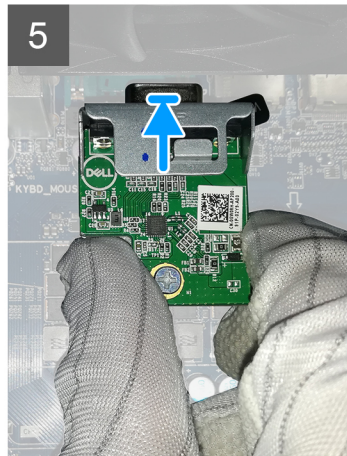
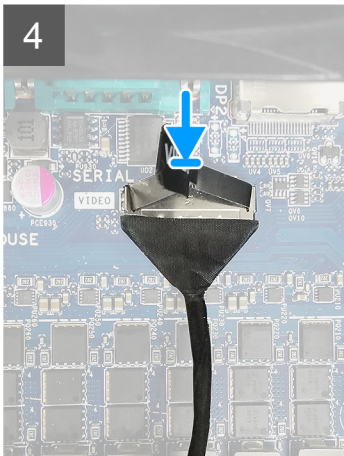
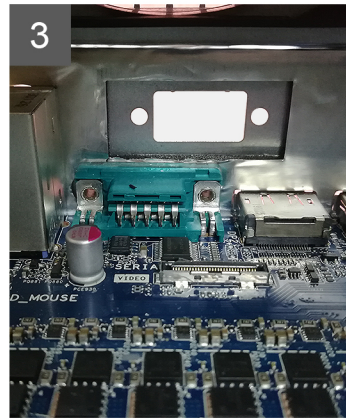
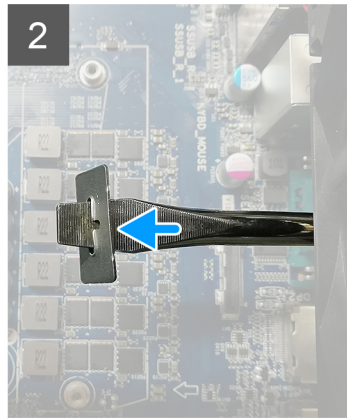
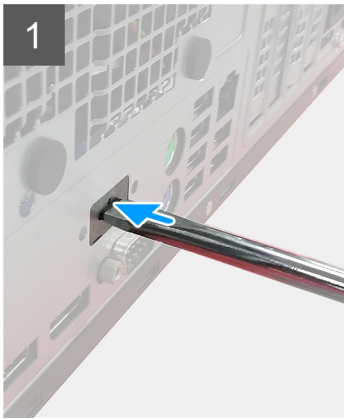

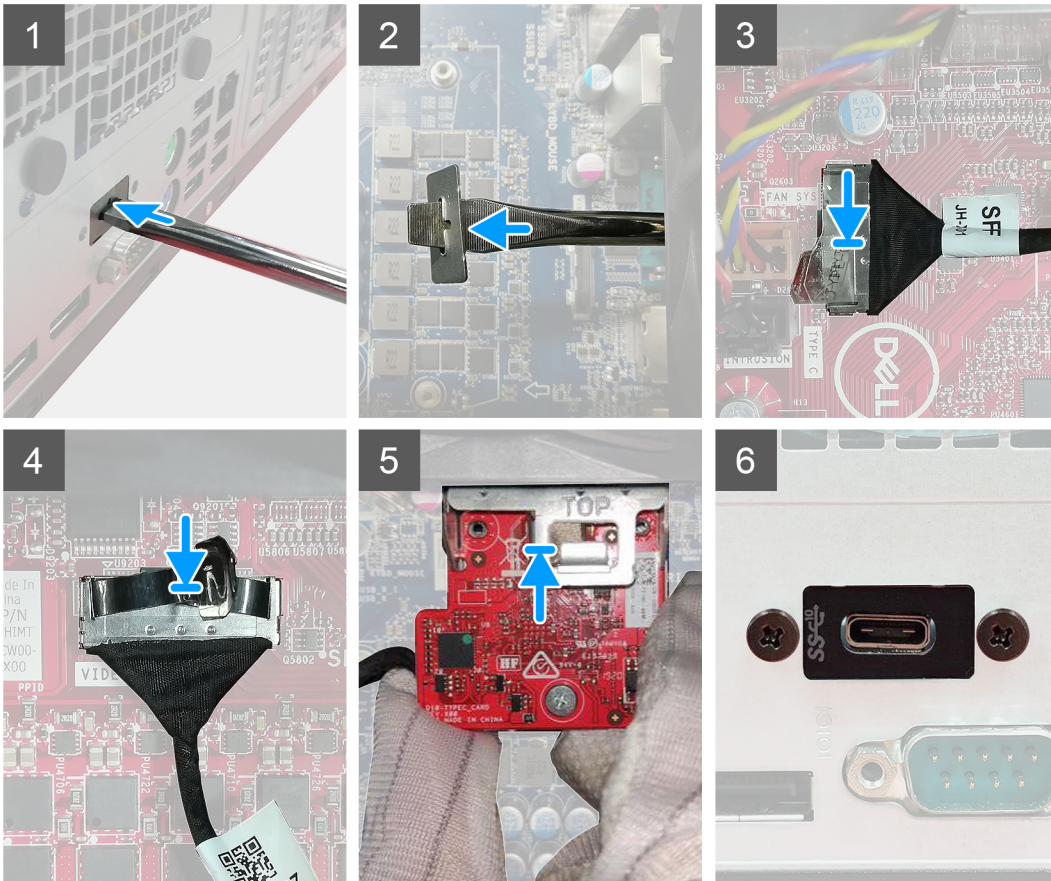

Steps

1. To remove the dummy metal bracket, insert a flathead screwdriver in the hole of the bracket, push the bracket to release the bracket, and then lift the bracket out from the system.
2. Insert the optional I/O module (Type-C/HDMI/VGA/DP/Serial) into its slot from the inside of your computer.
3. Connect the I/O cable to the connector on the system board .
4. Replace the two (M3X3) screws to secure the optional I/O module to the system.

Next steps

1. Install the [fan duct](#).
2. Install the [front bezel](#).
3. Install the [side cover](#).
4. Follow the procedure in [after working inside your computer](#).

System board

Removing the system board

Prerequisites

1. Follow the procedure in [before working inside your computer](#).
 - NOTE:** Your computer's Service Tag is stored in the system board. You must enter the Service Tag in the BIOS setup program after you replace the system board.
 - NOTE:** Replacing the system board removes any changes that you have made to the BIOS using the BIOS setup program. You must make the appropriate changes again after you replace the system board.
 - NOTE:** Before disconnecting the cables from the system board, note the location of the connectors so that you can reconnect the cables correctly after you replace the system board.
2. Remove the [side cover](#).
3. Remove the [front bezel](#).
4. Remove the [fan duct](#).
5. Remove the [memory module](#).
6. Remove the [wireless](#).
7. Remove the [M.2 2230 SSD/M.2 2280 SSD](#).
8. Remove the [coin-cell battery](#).
9. Remove the [graphics card/ powered graphical processing unit](#).
10. Remove the [processor fan and heat-sink assembly](#).
11. Remove the [processor](#).

About this task

The following images indicate the location of the system board and provides a visual representation of the removal procedure.

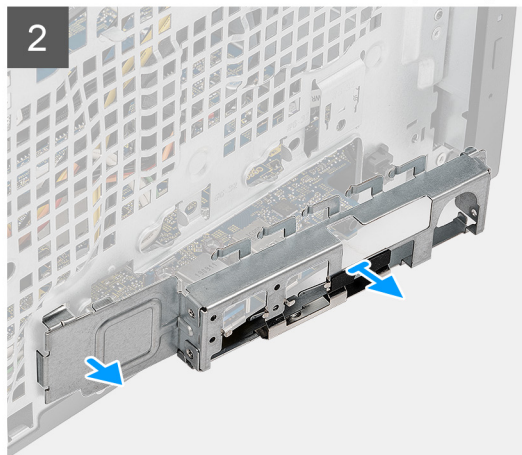
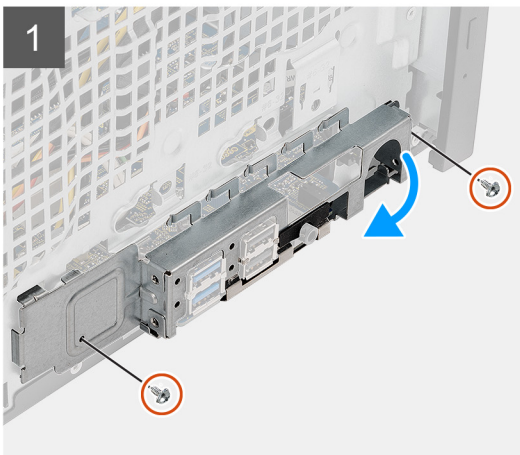
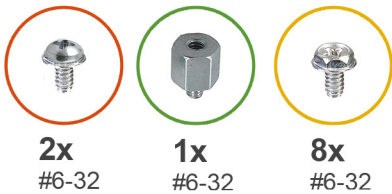
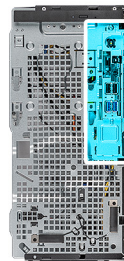



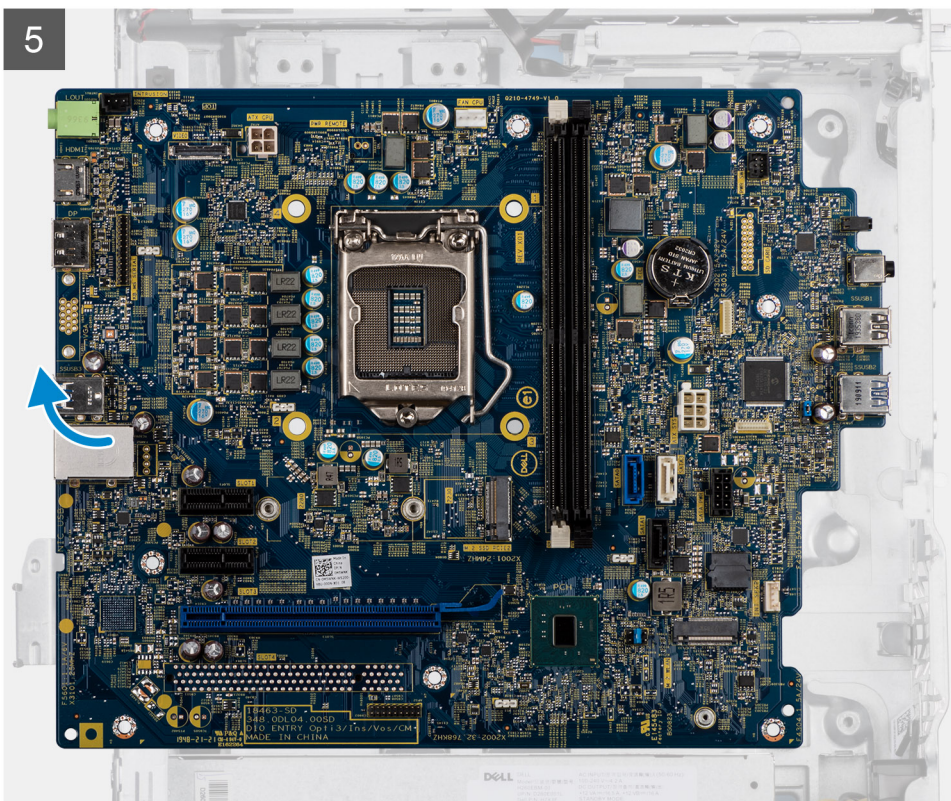
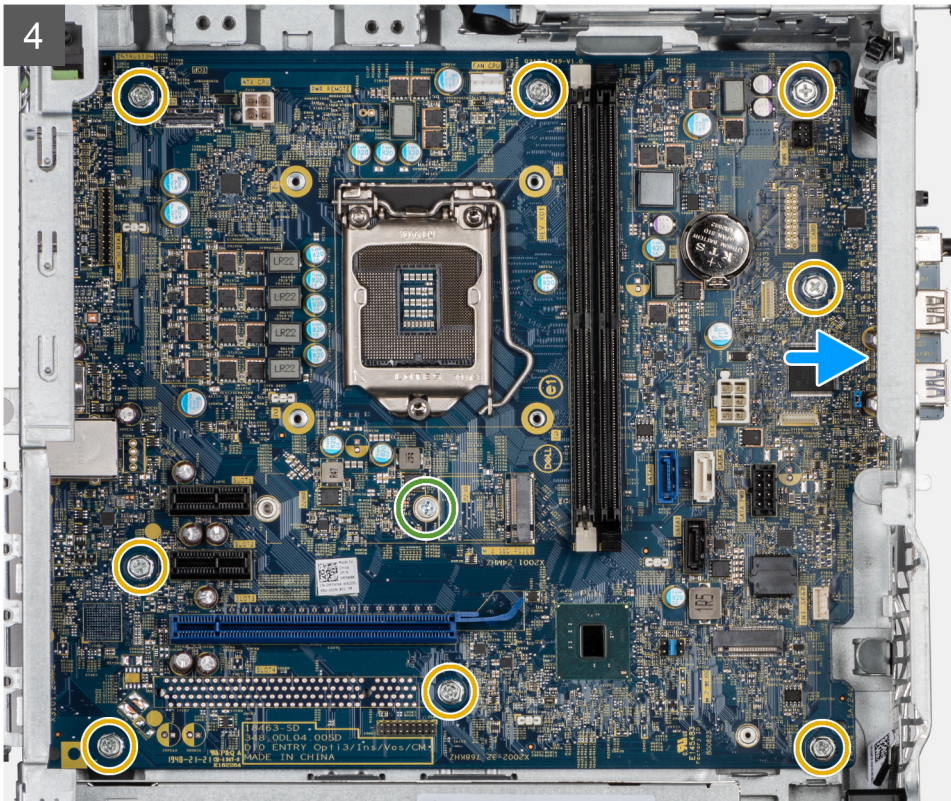

Steps

1. Remove the two (#6-32) screws that secure the front I/O-bracket to the chassis.
2. Slide and remove the front I/O-bracket from the chassis.
3. Disconnect all the cables that are connected to the system board.
4. Remove the M.2 card standoff (#6-32) screw and eight (#6-32) screws that secure the system board to the chassis.

5. Lift the system board at an angle and remove the system board off the chassis.

Installing the system board

Prerequisites

If you are replacing a component, remove the existing component before performing the installation procedure.

About this task

The following images indicate the location of the system board and provides a visual representation of the installation procedure.

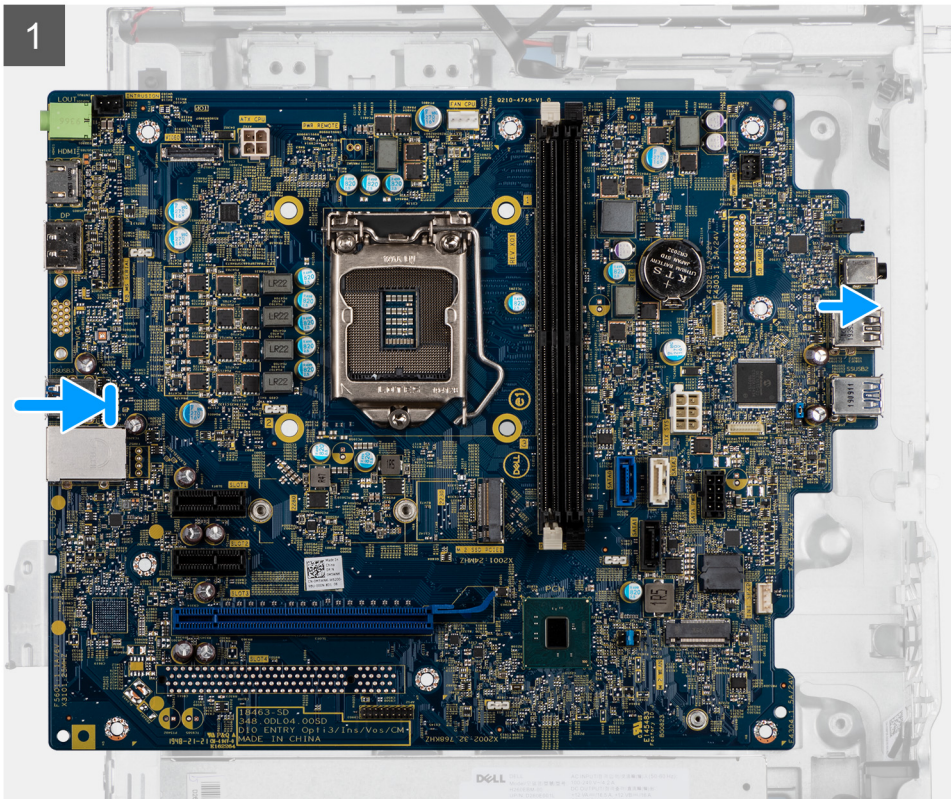
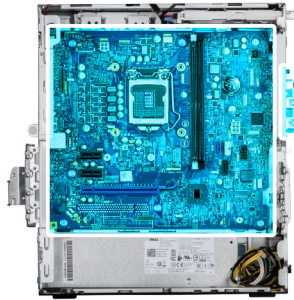
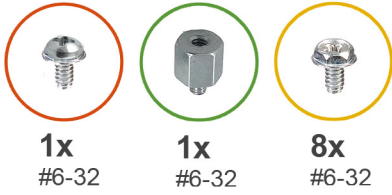

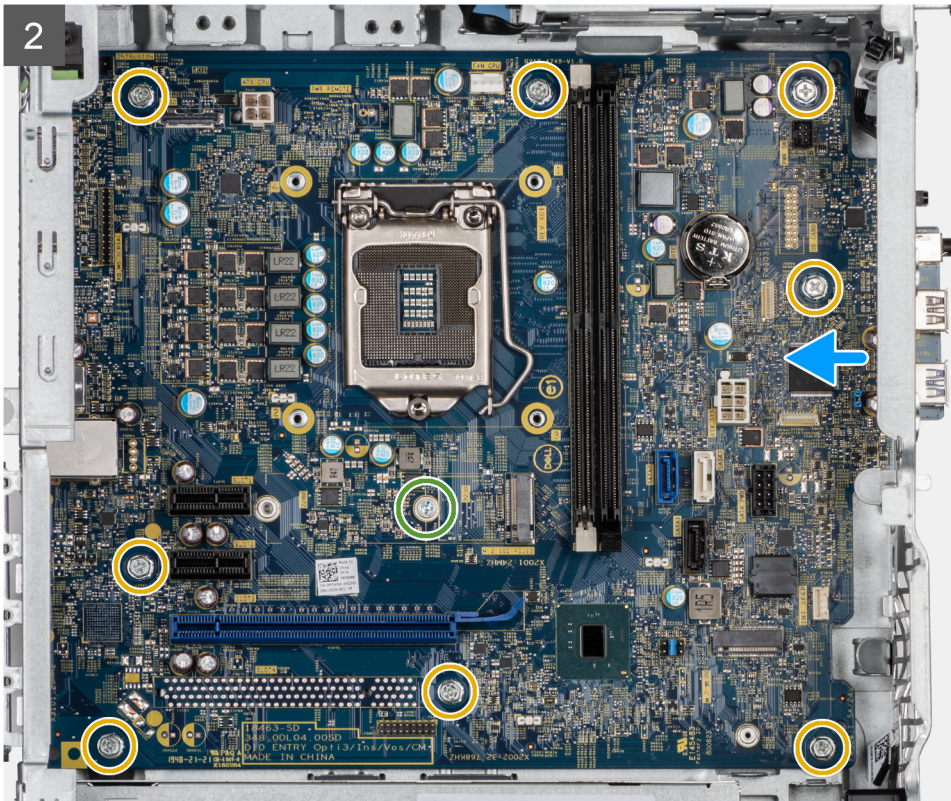

3



4

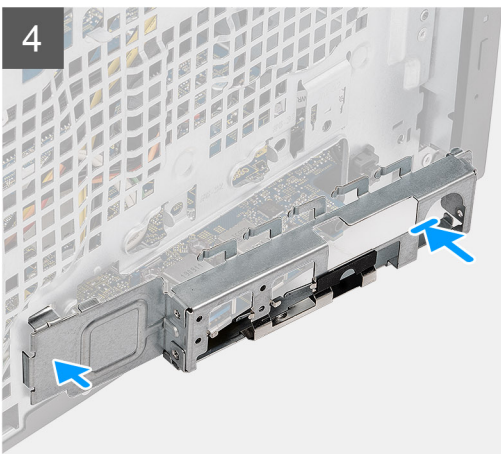

5

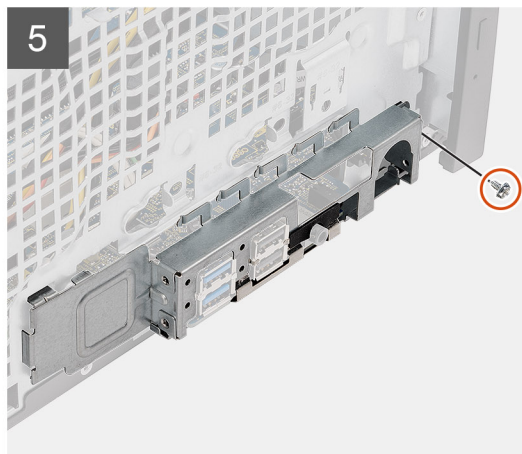

Steps

1. Slide the front I/O-ports on the system board into the front I/O-slots on the chassis and align the screw holes on the system board with the screw holes on the chassis.
2. Replace the M.2 card standoff (#6-32) screw and eight (#6-32) screws that secure the system board to the chassis.
3. Route and connect all the cables to the connectors on the system board.

4. Align the front I/O-bracket with the slots on the chassis.
5. Replace the two (#6-32) screws to secure the front I/O-bracket to the chassis.

Next steps

1. Install the [processor](#).
 2. Install the [processor fan and heat-sink assembly](#).
 3. Install the [coin-cell battery](#).
 4. Install the [graphics card/powered GPU](#).
 5. Install the [M.2 2230 SSD/M.2 2280 SSD](#).
 6. Install the [wireless](#).
 7. Install the [memory module](#).
 8. Install the [fan duct](#)
 9. Install the [front bezel](#).
 10. Install the [side cover](#).
 11. Follow the procedure in [after working inside your computer](#).
- i** **NOTE:** Your computer's Service Tag is stored in the system board. You must enter the Service Tag in the BIOS setup program after you replace the system board.
- i** **NOTE:** Replacing the system board removes any changes that you have made to the BIOS using the BIOS setup program. You must make the appropriate changes again after you replace the system board.

Troubleshooting

Topics:

- [Dell SupportAssist Pre-boot System Performance Check diagnostics](#)
- [Diagnostic LED behavior](#)
- [Diagnostic error messages](#)
- [System error messages](#)
- [WiFi power cycle](#)

Dell SupportAssist Pre-boot System Performance Check diagnostics

About this task

The SupportAssist diagnostics (also known as system diagnostics) performs a complete check of your hardware. The Dell SupportAssist Pre-boot System Performance Check diagnostics is embedded with the BIOS and is launched by the BIOS internally. The embedded system diagnostics provides a set of options for particular devices or device groups allowing you to:

- Run tests automatically or in an interactive mode
- Repeat tests
- Display or save test results
- Run thorough tests to introduce additional test options to provide extra information about the failed device(s)
- View status messages that inform you if tests are completed successfully
- View error messages that inform you of problems encountered during testing

 **NOTE:** Some tests for specific devices require user interaction. Always ensure that you are present at the computer terminal when the diagnostic tests are performed.

For more information, see [Resolve Hardware Issues With Built-in and Online Diagnostics \(SupportAssist ePSA, ePSA or PSA Error Codes\)](#).

Running the SupportAssist Pre-Boot System Performance Check

Steps

1. Turn on your computer.
2. As the computer boots, press the F12 key as the Dell logo appears.
3. On the boot menu screen, select the **Diagnostics** option.
4. Click the arrow at the bottom left corner.
Diagnostics front page is displayed.
5. Click the arrow in the lower-right corner to go to the page listing.
The items detected are listed.
6. To run a diagnostic test on a specific device, press Esc and click **Yes** to stop the diagnostic test.
7. Select the device from the left pane and click **Run Tests**.
8. If there are any issues, error codes are displayed.
Note the error code and validation number and contact Dell.

Diagnostic LED behavior

Table 7. Diagnostic LED behavior

Blinking pattern		Problem description	Suggested resolution
Amber	White		
1	2	Unrecoverable SPI Flash Failure	
2	1	CPU failure	<ul style="list-style-type: none"> • Run the Intel CPU diagnostics tools. • If problem persists, replace the system board.
2	2	System board failure (included BIOS corruption or ROM error)	<ul style="list-style-type: none"> • Flash latest BIOS version • If problem persists, replace the system board.
2	3	No memory/RAM detected	<ul style="list-style-type: none"> • Confirm that the memory module is installed properly. • If problem persists, replace the memory module.
2	4	Memory/RAM failure	<ul style="list-style-type: none"> • Reset the memory module. • If problem persists, replace the memory module.
2	5	Invalid memory installed	<ul style="list-style-type: none"> • Reset the memory module. • If problem persists, replace the memory module.
2	6	System board / Chipset Error / Clock failure / Gate A20 failure / Super I/O failure / Keyboard controller failure	<ul style="list-style-type: none"> • Flash latest BIOS version • If problem persists, replace the system board.
3	1	CMOS battery failure	<ul style="list-style-type: none"> • Reset the CMOS battery connection. • If problem persists, replace the RTS battery.
3	2	PCI or Video card/chip failure	Replace the system board.
3	3	BIOS Recovery image not found	<ul style="list-style-type: none"> • Flash latest BIOS version • If problem persists, replace the system board.
3	4	BIOS Recovery image found but invalid	<ul style="list-style-type: none"> • Flash latest BIOS version • If problem persists, replace the system board.
3	5	Power rail failure	<ul style="list-style-type: none"> • EC ran into power sequencing failure. • If problem persists, replace the system board.

Table 7. Diagnostic LED behavior (continued)

Blinking pattern		Problem description	Suggested resolution
Amber	White		
3	6	SBIOS Flash corruption	<ul style="list-style-type: none"> Flash corruption detected by SBIOS If problem persists, replace the system board.
3	7	Intel ME (Management Engine) Error	<ul style="list-style-type: none"> Timeout waiting on ME to reply to HECI message If problem persists, replace the system board.
4	2	CPU Power Cable Connection Issue	

Diagnostic error messages

Table 8. Diagnostic error messages

Error messages	Description
AUXILIARY DEVICE FAILURE	The touchpad or external mouse may be faulty. For an external mouse, check the cable connection. Enable the Pointing Device option in the System Setup program.
BAD COMMAND OR FILE NAME	Ensure that you have spelled the command correctly, put spaces in the proper place, and used the correct path name.
CACHE DISABLED DUE TO FAILURE	The primary cache internal to the microprocessor has failed. Contact Dell
CD DRIVE CONTROLLER FAILURE	The optical drive does not respond to commands from the computer.
DATA ERROR	The hard drive cannot read the data.
DECREASING AVAILABLE MEMORY	One or more memory modules may be faulty or improperly seated. Reinstall the memory modules or, if necessary, replace them.
DISK C: FAILED INITIALIZATION	The hard drive failed initialization. Run the hard drive tests in Dell Diagnostics .
DRIVE NOT READY	The operation requires a hard drive in the bay before it can continue. Install a hard drive in the hard drive bay.
ERROR READING PCMCIA CARD	The computer cannot identify the ExpressCard. Reinsert the card or try another card.
EXTENDED MEMORY SIZE HAS CHANGED	The amount of memory recorded in non-volatile memory (NVRAM) does not match the memory module installed in the computer. Restart the computer. If the error appears again, Contact Dell
THE FILE BEING COPIED IS TOO LARGE FOR THE DESTINATION DRIVE	The file that you are trying to copy is too large to fit on the disk, or the disk is full. Try copying the file to a different disk or use a larger capacity disk.
A FILENAME CANNOT CONTAIN ANY OF THE FOLLOWING CHARACTERS: \ / : * ? " < > -	Do not use these characters in filenames.
GATE A20 FAILURE	A memory module may be loose. Reinstall the memory module or, if necessary, replace it.

Table 8. Diagnostic error messages (continued)

Error messages	Description
GENERAL FAILURE	The operating system is unable to carry out the command. The message is usually followed by specific information. For example, <i>Printer out of paper</i> . Take the appropriate action.
HARD-DISK DRIVE CONFIGURATION ERROR	The computer cannot identify the drive type. Shut down the computer, remove the hard drive, and boot the computer from an optical drive. Then, shut down the computer, reinstall the hard drive, and restart the computer. Run the Hard Disk Drive tests in Dell Diagnostics .
HARD-DISK DRIVE CONTROLLER FAILURE 0	The hard drive does not respond to commands from the computer. Shut down the computer, remove the hard drive, and boot the computer from an optical drive. Then, shut down the computer, reinstall the hard drive, and restart the computer. If the problem persists, try another drive. Run the Hard Disk Drive tests in Dell Diagnostics .
HARD-DISK DRIVE FAILURE	The hard drive does not respond to commands from the computer. Shut down the computer, remove the hard drive, and boot the computer from an optical drive. Then, shut down the computer, reinstall the hard drive, and restart the computer. If the problem persists, try another drive. Run the Hard Disk Drive tests in Dell Diagnostics .
HARD-DISK DRIVE READ FAILURE	The hard drive may be defective. Shut down the computer, remove the hard drive, and boot the computer from an optical drive. Then, shut down the computer, reinstall the hard drive, and restart the computer. If the problem persists, try another drive. Run the Hard Disk Drive tests in Dell Diagnostics .
INSERT BOOTABLE MEDIA	The operating system is trying to boot to non-bootable media, such as an optical drive. Insert bootable media.
INVALID CONFIGURATION INFORMATION-PLEASE RUN SYSTEM SETUP PROGRAM	The system configuration information does not match the hardware configuration. The message is most likely to occur after a memory module is installed. Correct the appropriate options in the system setup program.
KEYBOARD CLOCK LINE FAILURE	For external keyboards, check the cable connection. Run the Keyboard Controller test in Dell Diagnostics .
KEYBOARD CONTROLLER FAILURE	For external keyboards, check the cable connection. Restart the computer, and avoid touching the keyboard or the mouse during the boot routine. Run the Keyboard Controller test in Dell Diagnostics .
KEYBOARD DATA LINE FAILURE	For external keyboards, check the cable connection. Run the Keyboard Controller test in Dell Diagnostics .
KEYBOARD STUCK KEY FAILURE	For external keyboards or keypads, check the cable connection. Restart the computer, and avoid touching the keyboard or keys during the boot routine. Run the Stuck Key test in Dell Diagnostics .
LICENSED CONTENT IS NOT ACCESSIBLE IN MEDIADIRECT	Dell MediaDirect cannot verify the Digital Rights Management (DRM) restrictions on the file, so the file cannot be played.
MEMORY ADDRESS LINE FAILURE AT ADDRESS, READ VALUE EXPECTING VALUE	A memory module may be faulty or improperly seated. Reinstall the memory module or, if necessary, replace it.
MEMORY ALLOCATION ERROR	The software you are attempting to run is conflicting with the operating system, another program, or a utility. Shut down the computer, wait for 30 seconds, and then restart it. Run the

Table 8. Diagnostic error messages (continued)

Error messages	Description
	program again. If the error message still appears, see the software documentation.
MEMORY DOUBLE WORD LOGIC FAILURE AT ADDRESS, READ VALUE EXPECTING VALUE	A memory module may be faulty or improperly seated. Reinstall the memory module or, if necessary, replace it.
MEMORY ODD/EVEN LOGIC FAILURE AT ADDRESS, READ VALUE EXPECTING VALUE	A memory module may be faulty or improperly seated. Reinstall the memory module or, if necessary, replace it.
MEMORY WRITE/READ FAILURE AT ADDRESS, READ VALUE EXPECTING VALUE	A memory module may be faulty or improperly seated. Reinstall the memory module or, if necessary, replace it.
NO BOOT DEVICE AVAILABLE	The computer cannot find the hard drive. If the hard drive is your boot device, ensure that the drive is installed, properly seated, and partitioned as a boot device.
NO BOOT SECTOR ON HARD DRIVE	The operating system may be corrupted, Contact Dell.
NO TIMER TICK INTERRUPT	A chip on the system board may be malfunctioning. Run the System Set tests in Dell Diagnostics.
NOT ENOUGH MEMORY OR RESOURCES. EXIT SOME PROGRAMS AND TRY AGAIN	You have too many programs open. Close all windows and open the program that you want to use.
OPERATING SYSTEM NOT FOUND	Reinstall the operating system. If the problem persists, Contact Dell.
OPTIONAL ROM BAD CHECKSUM	The optional ROM has failed. Contact Dell.
SECTOR NOT FOUND	The operating system cannot locate a sector on the hard drive. You may have a defective sector or corrupted File Allocation Table (FAT) on the hard drive. Run the Windows error-checking utility to check the file structure on the hard drive. See Windows Help and Support for instructions (click Start > Help and Support). If a large number of sectors are defective, back up the data (if possible), and then format the hard drive.
SEEK ERROR	The operating system cannot find a specific track on the hard drive.
SHUTDOWN FAILURE	A chip on the system board may be malfunctioning. Run the System Set tests in Dell Diagnostics. If the message reappears, Contact Dell.
TIME-OF-DAY CLOCK LOST POWER	System configuration settings are corrupted. Connect your computer to an electrical outlet to charge the battery. If the problem persists, try to restore the data by entering the System Setup program, then immediately exit the program. If the message reappears, Contact Dell.
TIME-OF-DAY CLOCK STOPPED	The reserve battery that supports the system configuration settings may require recharging. Connect your computer to an electrical outlet to charge the battery. If the problem persists, Contact Dell.
TIME-OF-DAY NOT SET-PLEASE RUN THE SYSTEM SETUP PROGRAM	The time or date stored in the system setup program does not match the system clock. Correct the settings for the Date and Time options.
TIMER CHIP COUNTER 2 FAILED	A chip on the system board may be malfunctioning. Run the System Set tests in Dell Diagnostics.
UNEXPECTED INTERRUPT IN PROTECTED MODE	The keyboard controller may be malfunctioning, or a memory module may be loose. Run the System Memory tests and the Keyboard Controller test in Dell Diagnostics or Contact Dell.

Table 8. Diagnostic error messages (continued)

Error messages	Description
X:\ IS NOT ACCESSIBLE. THE DEVICE IS NOT READY	Insert a disk into the drive and try again.

System error messages

Table 9. System error messages

System message	Description
Alert! Previous attempts at booting this system have failed at checkpoint [nnnn]. For help in resolving this problem, please note this checkpoint and contact Dell Technical Support	The computer failed to complete the boot routine three consecutive times for the same error.
CMOS checksum error	RTC is reset, BIOS Setup default has been loaded.
CPU fan failure	CPU fan has failed.
System fan failure	System fan has failed.
Hard-disk drive failure	Possible hard disk drive failure during POST.
Keyboard failure	Keyboard failure or loose cable. If reseating the cable does not solve the problem, replace the keyboard.
No boot device available	No bootable partition on hard disk drive, the hard disk drive cable is loose, or no bootable device exists. <ul style="list-style-type: none"> • If the hard drive is your boot device, ensure that the cables are connected and that the drive is installed properly and partitioned as a boot device. • Enter system setup and ensure that the boot sequence information is correct.
No timer tick interrupt	A chip on the system board might be malfunctioning or motherboard failure.
NOTICE - Hard Drive SELF MONITORING SYSTEM has reported that a parameter has exceeded its normal operating range. Dell recommends that you back up your data regularly. A parameter out of range may or may not indicate a potential hard drive problem	S.M.A.R.T error, possible hard disk drive failure.

WiFi power cycle

About this task

If your computer is unable to access the internet due to WiFi connectivity issues a WiFi power cycle procedure may be performed. The following procedure provides the instructions on how to conduct a WiFi power cycle:

 **NOTE:** Some ISPs (Internet Service Providers) provide a modem/router combo device.

Steps

1. Turn off your computer.
2. Turn off the modem.
3. Turn off the wireless router.
4. Wait for 30 seconds.

5. Turn on the wireless router.
6. Turn on the modem.
7. Turn on your computer.

Getting help

Topics:

- [Contacting Dell](#)

Contacting Dell

Prerequisites

 **NOTE:** If you do not have an active Internet connection, you can find contact information on your purchase invoice, packing slip, bill, or Dell product catalog.

About this task

Dell provides several online and telephone-based support and service options. Availability varies by country and product, and some services may not be available in your area. To contact Dell for sales, technical support, or customer service issues:

Steps

1. Go to **Dell.com/support**.
2. Select your support category.
3. Verify your country or region in the **Choose a Country/Region** drop-down list at the bottom of the page.
4. Select the appropriate service or support link based on your need.